

25 Code GTO Digital Keypad

Instructions for Wired and Wireless Installations (F137-G3 only)



Thank you for purchasing the GTO Digital Keypad. Be sure to read the directions carefully and completely. Before permanently mounting the keypad, please program the keypad and test its range.

IMPORTANT: Your keypad may need to be hard wired due to the fact that it must accept interference according to FCC regulations listed below. For example, applications that are relatively close to cell towers or airports may receive intermittent interference and require hard-wiring.

The GTO Digital Keypad is a multipurpose keypad that can work with other applications in addition to GTO gate openers and locks. As a wireless keypad it can be used with any gate or garage door opener and must be used in conjunction with the GTO garage door receiver kit (part # RB709U-NB).

SAFETY NOTE: Never install the keypad where a person can reach through the gate to activate it, or where a person can touch the gate while activating the keypad. The recommended minimum distance between the gate and keypad is 10 ft.

FCC WARNING: Changes or modifications to this unit not expressly approved by the party responsible for compliance could void the user's authority to operate the equipment.

NOTE: This equipment has been tested and found to comply with the limits for a Class B digital device, pursuant to Part 15 of the FCC Rules. These limits are designed to provide reasonable protection against harmful interference in a residential installation. This equipment generates, uses and can radiate radio frequency energy and, if not installed and used in accordance with the instructions, may cause harmful interference to radio communications.

However, there is no guarantee that interference will not occur in particular installations. If this equipment does cause harmful interference to radio or television reception, which can be determined by turning the equipment off and on, the user is encouraged to try to correct the interference by one or more of the following measures: • Reorient or replace the receiver antenna. • Increase the separation between the equipment and the receiver. • Connect the equipment into an outlet on a circuit different from that to which the receiver is connected. • Consult the dealer or an experienced radio/TV technician for help.

Keypad Features

Keypad

- The keypad illuminates and beeps at the press of any key.
- When a valid code is entered, the STATUS light will blink rapidly.
- The keypad remains active for 40 seconds after entering a valid code: pressing any key on the keypad while the gate is in motion will stop the gate; pressing any key while the gate is stopped will cause the gate to reverse direction. After 40 seconds, the keypad will beep 3 three times and go into "idle" mode.
- If more than 20 key presses are entered without matching an Entry Code, the STATUS light will flash rapidly, an error tone will sound for 1 second, and the keypad will go into "lock-down" mode for 40 seconds.
- If more than 10 seconds elapse between key presses, the keypad will beep 3 three times and go into "idle" mode.

Master and Entry Codes

- Up to 25 Entry Codes may be programmed into the keypad.
- Temporary Entry Codes can be programmed to expire within one to seven (1–7) days.
- Entry Codes remain stored in memory even when the keypad batteries go dead.
- All Entry Codes are deleted by pressing the RESET button on the keypad; Master Code defaults to "1234."

Limited One Year Warranty

GTO Access Systems (GTO) gate opener accessories are warranted by the manufacturer against defects in workmanship for a period of one (1) year from the date of purchase, provided recommended installation procedures have been followed.

In the case of product failure due to defective material or manufacturer workmanship within the one (1) year warranty period, the accessory will be repaired or replaced (at the manufacturer's option) at no charge to the customer, if returned freight prepaid to GTO, 3121 Hartsfield Rd., Tallahassee, FL 32303. **IMPORTANT:** Call 850/575-4144 or fax 850/575-8950 for a Return Goods Authorization (RGA) number before returning goods to factory. Products received at the factory without an RGA will not be accepted. Replacement or repaired parts are covered by this warranty for the remainder of the one (1) year warranty period or six (6) months, whichever is greater. GTO will pay the shipping charges for return to the owner of items repaired.

The manufacturer will not be responsible for any charges or damages incurred in the removal of the defective parts for repair, or for the re-installation of those parts after repair. This warranty shall be considered void if damage to the product(s) was due to improper installation or use, connection to an improper power source, tampering, or if damage was caused by electrical power surge or lightning, wind, fire, flood, insects, or other natural agent.

After the one (1) year warranty period, GTO or one of its authorized service centers will make any necessary repairs for a nominal fee. Call GTO at 850/575-4144 for more information. This warranty gives you specific legal rights, and you may also have other rights which may vary from state to state. This warranty is in lieu of all other warranties, expressed or implied. **NOTE:** Verification of the warranty period requires copies of receipts or other proof of purchase. Please retain these for your records.

Table of Contents

Keypad Features	Cover
Warranty Information	Cover
Keypad Description	3
Installing Batteries	3
Wireless Installation of the Keypad	3
“Learn” Transmitter Code	3
Wired Installation of the Keypad	4
Control Board Connection Examples	4
Program the Keypad	5
Normal Keypad Operation	6
Keying Indication Summary	6
Notes	7

FOR YOUR RECORDS

Please record the following information. Be sure to **keep all receipts for proof of purchase**. Refer to this information when calling GTO for service or assistance with your keypad.

Date of Purchase: _____

Place of Purchase: _____

Factory Code

<input type="text" value="1"/>	<input type="text" value="2"/>	<input type="text" value="3"/>	<input type="text" value="4"/>
--------------------------------	--------------------------------	--------------------------------	--------------------------------

Your Master Code

<input type="text"/>	<input type="text"/>	<input type="text"/>	<input type="text"/>
----------------------	----------------------	----------------------	----------------------

Additional Codes (Up to 25): _____

Keypad Description

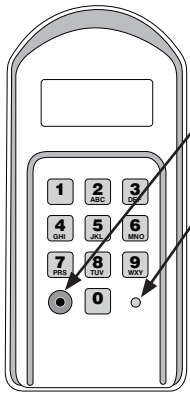

Keypad - Front

PROGRAM Button:
Use for / during program process.

STATUS Light:
The LED will blink once when any key is pressed and provides visual feedback during access code programming.

FIG. 1

FIG. 2

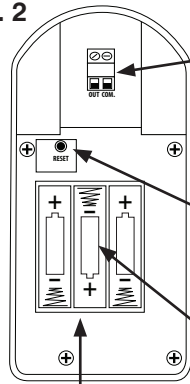

Keypad - Inside

Open Collector Output:
Used to connect Keypad to gate opener that accepts logic inputs (All GTO gate openers) in hard-wired applications.

RESET Button:
Pressing this button for 2 seconds will reprogram keypad to factory settings. All codes are deleted. Default master code is 1234.

Battery Holder:
Use 3 AA batteries.

Installing Batteries

NOTE: 3 AA batteries are required to power the keypad.

Step 1: Remove the two screws from the bottom of the keypad (FIG. 3) and separate the keypad from its housing.

Step 2: Install 3 AA batteries (not included). (FIG. 2) **NOTE:** Choose *wireless or wired* installation (not both) and proceed to appropriate section.

Wireless Installation of the Keypad

NOTE: For wireless applications, the distance from the keypad to the opener's receiver should not exceed 50 ft. Always test the keypad range before permanently mounting it.

Step 1: Mount the keypad cover using the screws provided.

Step 2: Slide the keypad into the cover and secure with the small screws provided.

NOTE: If you have not changed your opener's transmitter code from the factory setting, see the "Setting Your Personal Transmitter Code" section in the gate opener's manual then "Learn" the transmitter code into the keypad. See "Learn Transmitter Code" section below.

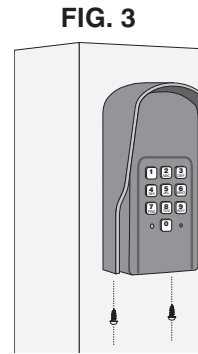

FIG. 3

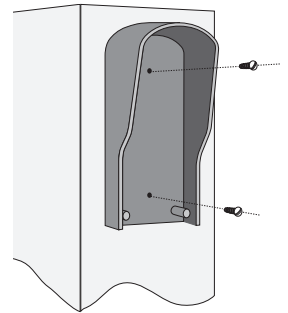

FIG. 4

"Learn" Transmitter Code

(for wireless installation)

IMPORTANT: Make sure the transmitter operates the gate opener.

Turn off the gate opener so that there is no unintended operation of the gate during the learning process.

- 1 Press and release the **PROGRAM** button.
- 2 Enter the **Master Code** then press and release the **PROGRAM** button.
- 3 Enter **0,5** then press and release the **PROGRAM** button.
- 4 Press and hold the transmitter button while holding the transmitter to the bottom of the keypad as shown.
- 5 The keypad will beep 3 times to confirm that the transmitter is successfully "Learned." Release the transmitter button at this time.

Example: Learn transmitter code with Master Code of "1234". Then press and hold transmitter button until you hear 3 beeps. The round black dot is the "PROGRAM" button. Go to "Programming the keypad" to change the master code (if desired)



Turn the gate opener back on and confirm that the keypad operates the gate using the master code.

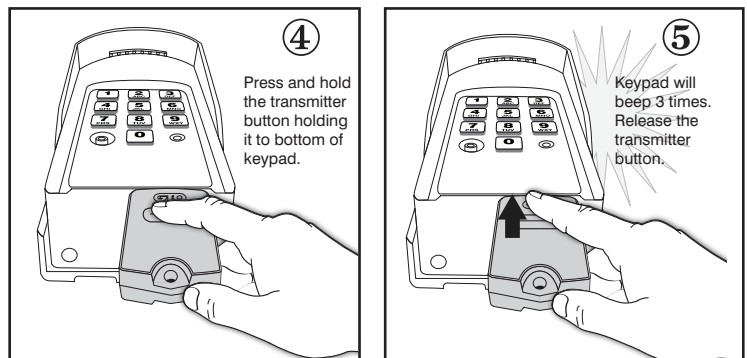
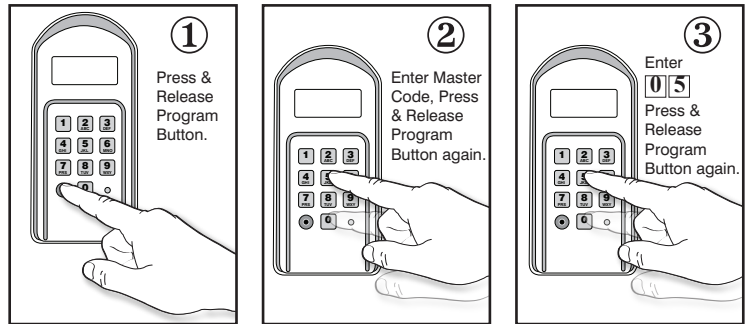

IMPORTANT: Transmitter must be placed exactly as shown, and against the bottom of the keypad in order for the "learning" process to work correctly.

Wired Installation of the Keypad

IMPORTANT: Remove the batteries from the keypad. The keypad will not work properly if batteries are not first removed.

Step 1: Turn the gate opener's power switch **OFF**. Run wire through PVC pipe between the opener control board to protect the wire.

Remove the small rectangular knock-out on the back of the keypad cover and pull the wire into the cover. Then mount the cover to the post using the screws provided. (FIG. 6)

Step 2: Strip the wires back 3/16" and attach the wires to the terminal block marked OUT COM on the keypad control board as shown in (FIG. 7) making sure to keep track of polarity. Connect the other end to the opener's control board as shown in Control Board Connections section below.

NOTE: For a hard-wired application the 318 MHz RF transmitter is automatically disabled.

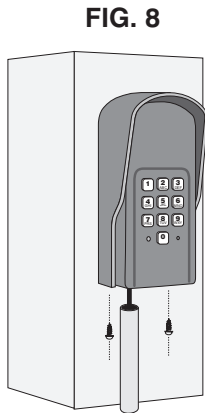
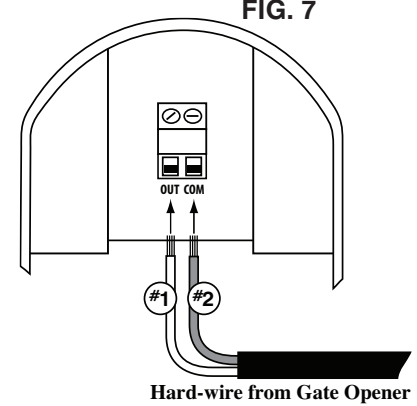
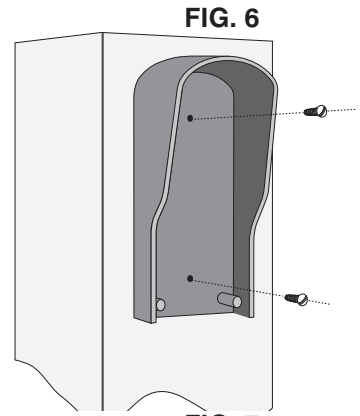

Step 3: With the power to the opener turned **OFF**. Remove opener control board cover and feed enough of the low voltage keypad wire through a strain relief to reach the gate opener control board terminals.

Step 4: Attach the wires from the keypad to the opener control board terminal blocks as shown below. (FIG. 9)

Step 5: Replace the control board cover and turn the power switch **ON**. Put the batteries back into the keypad. (FIG. 2) Test the keypad by entering **1 2 3 4** to open gate.

Step 6: Program new "Personal Master Code" and any additional entry codes (for a total of 25 entry codes) (if desired). See [Program the Keypad on page 5](#).

Step 7: Slide the keypad into the cover and secure with the small screws provided. (FIG. 8)

Control Board Connection Examples

NOTE: If your control board doesn't look like any of these diagrams, please refer to the opener's instruction manual to locate the control board input.

FIG. 9

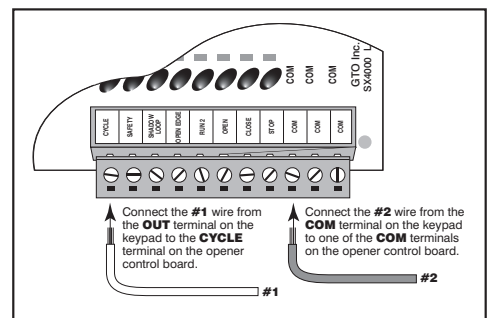
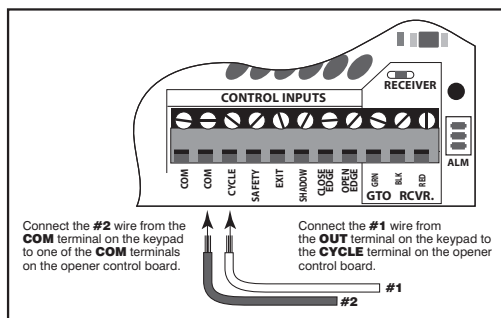
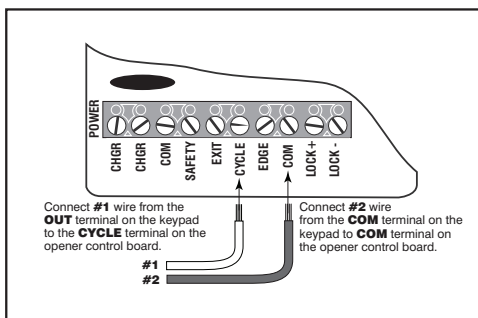
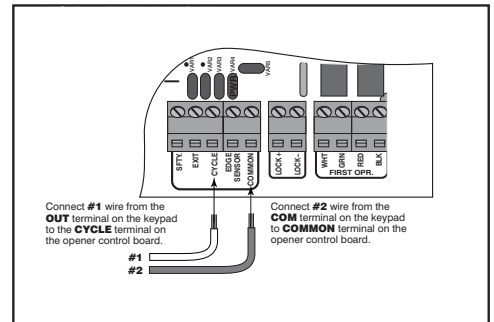
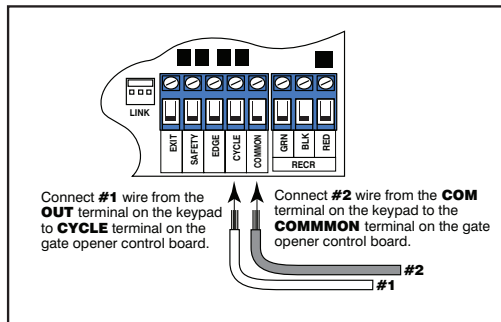
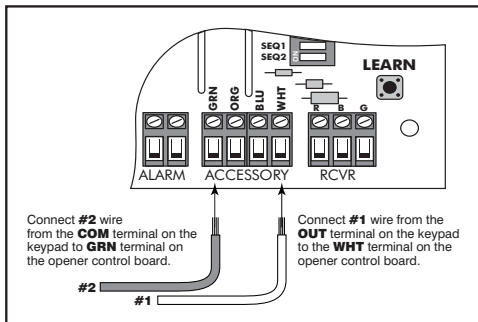



Program the Keypad

- A Master Code is needed to add, remove, or program Entry Codes.
- Factory default Master Code is “1234.”
- Keypad can only enter “program” mode from “idle” mode.
- Keypad will beep three times before going into “idle” mode (more than 10 seconds between key presses).



Program Button Status Light





 **Programming Confirmed:** Keypad will beep 3 times.

 **Error Message:** Status light will flash rapidly, error tone will sound for 1 second and keypad will return to “idle” mode (changes not saved).



- Entry Code is not 4 digits.
- New Master Codes don't match (“Program New Master Code”).
- Memory is full (already 25 codes).
- No matching code is found (“Delete Entry Code”).

 = Your 4-digit code.



Program New Master Code

1. Press and Release Program Button: ●
2. Enter current Master Code:  (example: the factory default Master Code)
3. Press and Release Program Button: ●
4. Enter the Function Code: 
5. Press and Release Program Button: ●
6. Enter the *new* Master Code: 
7. Press and Release Program Button: ●
8. Enter the *new* Master Code again: 
9. Press and Release Program Button: ●



Add Temporary Entry Code

- *In step 4, you will need to enter a number from 1 through 7 to indicate the number of days until the Entry Code expires.
1. ●
 2.  Master Code
 3. ●
 4.  Function Code & # of days Code will be active*
 5. ●
 6.  Temporary Entry Code
 7. ●



Add New Entry Code

1. ●
2.  Master Code
3. ●
4.  Function Code
5. ●
6.  New Entry Code
7. ●

Delete Entry Code

1. ●
2.  Master Code
3. ●
4.  Function Code
5. ●
6.  Code to be deleted
7. ●

Delete All Entry Codes

1. ●
2.  Master Code
3. ●
4.  Function Code
5. ●

Normal Keypad Operation:



- If the user enters a 4-digit code that is matched to one of the 25 stored codes. The STATUS light should blink rapidly indicating that it is sending command to operator.
- No more than 20 key presses are allowed to obtain the 4-digit entry code.

Example:

1234 is one of the codes stored in one of the memory location.

The user can enter “x1234” or “xxxxxxxxxxxxxxxx1234” and the gate should be activated (x is any key). If more than 20 key presses is entered without matching one of the codes then the unit’s STATUS light should be flashing rapidly and no entry will be accepted for the next 40 seconds. The user must not enter any code for at least 40 seconds before the unit returns to normal operation; otherwise it remains in this “lock-down” mode. Once the user enters a matched code, any subsequent key press within the next 40 seconds will cause the keypad to send command to gate opener.

Keying Indication Summary:

	 Keying Error Alert Indication	 Keying accepted confirmation Indication
Master Code Setting	Speaker: continuous Beep for 2 seconds STATUS light: rapid flashing	Speaker: Beep – Beep – Beep STATUS light: no light, no flashing
Permanent Entry Code	Speaker: continuous Beep for 2 seconds STATUS light: rapid flashing	Speaker: Beep – Beep – Beep STATUS light: no light, no flashing
Temporary Entry Code Setting	Speaker: continuous Beep for 2 seconds STATUS light: rapid flashing	Speaker: Beep – Beep – Beep STATUS light: no light, no flashing
Entry Code Matching	Speaker: continuous Beep for 2 seconds STATUS light: rapid flashing	Speaker: Beep – Beep – Beep (after non-matching 20 keying) STATUS light: no light, no flashing

The contents of all material available on this installation manual are copyrighted by GTO Access Systems (“GTO”), unless otherwise indicated. All rights are reserved by GTO, and content may not be reproduced, downloaded, disseminated, published, or transferred in any form or by any means, except with the prior, written permission of GTO. Any reprinting of GTO publications is by permission only. Copyright infringement is a violation of federal law.

GTO®, GTO/PRO®, Mighty Mule® are registered trademarks of GTO Access Systems, and are the exclusive property of GTO. All rights are reserved by GTO, and these marks may not be used, in any for without the prior, written permission of GTO.



ACCESS SYSTEMS, LLC

**3121 Hartsfield Road • Tallahassee, Florida, USA 32303
(800) 543-4283 • Fax (850) 575-8912**