

QUICKFITTING[®]

PRODUCT CATALOG

**OVERBUILT,
NOT OVERPRICED.**

BRASS



STAINLESS STEEL

COPPER

QUICKFITTING[®] PUSH FITTINGS

U.S. Patent #8,205,915

655 Waterman Ave
East Providence, RI 02914
Tel: (877) 238-4826
Fax: (877) 258-4826



SCAN HERE

WITH YOUR PHONE OR
VISIT QUICKFITTING.COM
FOR MORE INFO

QUICKFITTING®

ABOUT US

Quick Fitting Holding Co. is an innovative U.S. inventor, manufacturer and supplier of quick connection technology that provides a simpler, safer, and a more cost-effective solution for connecting copper, PEX, PE-RT and CPVC piping in plumbing and heating applications. No open flames or sealants needed, just quickly clean the end of the pipe and push the fitting into place; a proven method used by professional contractors and advanced do-it-yourselfers alike.

Located in East Providence, Rhode Island, QuickFitting® has become a leading innovator in push-to-connect technology with more than 100 patents to its credit.

Our products are a great labor-saving tool. Our simple push fit technology makes it easy for plumbing professionals and the advanced do-it-yourselfers as well, saving the installer 70 - 90% of the installation time over conventional soldering or welding methods. For plumbing professionals, the increased speed offers the ability to complete more jobs in less time, increasing the number of daily service calls and their profitability. In addition, our fittings are designed and warranted to last longer than any other conventional method, up to 75 years.

We manufacture a broad selection of innovative push to connect products with a compelling competitive value proposition. In addition to our strengths as a high-quality, world-class manufacturing company, QuickFitting has consistently developed and delivered on new product innovations. Innovation is in everything we do at QuickFitting. Perhaps that's one reason QuickFitting has been honored twice by receiving the prestigious Plant Engineering "Product of the Year Award" for our innovations in push connect plumbing technology.



PUSH TO CONNECT PLUMBING PRODUCTS

NO ONE DOES THE JOB BETTER, FASTER.

Our products are a great labor-saving tool. Our simple technology makes it easy for the do-it-yourself plumber and plumbing professionals as well, saving the installer 70-90% of the installation time over conventional soldering or welding methods. For plumbing professionals, the increased speed means you complete more jobs in less time, increasing the number of daily service calls. In addition, our technology is designed and warranted to last longer than any other conventional method.



**WORKS ON COPPER, PEX, PE-RT, & CPVC.
INSTALLS IN SECONDS.**

HASSLE- AND FRUSTRATION-FREE APPLICATIONS

Just push to connect for a permanent plumbing connection in 1/4 the time of soldered technology.



REMOVABLE · REUSABLE · PUSH CONNECT · NO HARMFUL CHEMICALS · FULL FLOW

OUR TECHNOLOGY

BUILT TO LAST

Our patented technologies offer a full range of high-quality plumbing fittings and valves that are quick and easy to install. Our fittings are reusable, durable, permanent plumbing connections, and get the job done 75% faster than traditional methods, including soldering.

Over 100 patents are behind the technology that makes each of our fittings easy, durable, and reliable.

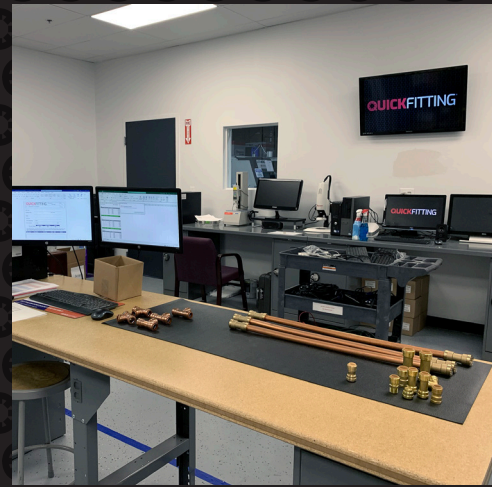

OUR PREMIUM CONSTRUCTION PROVIDES SUPERIOR PERFORMANCE AND THE INDUSTRY'S BEST WARRANTY.

Why install inferior metal or plastic fittings that are made or warranted to last about as long as a fluorescent bulb? Accept no substitutes, choose the only brand of fitting with an up to 75-year warranty.

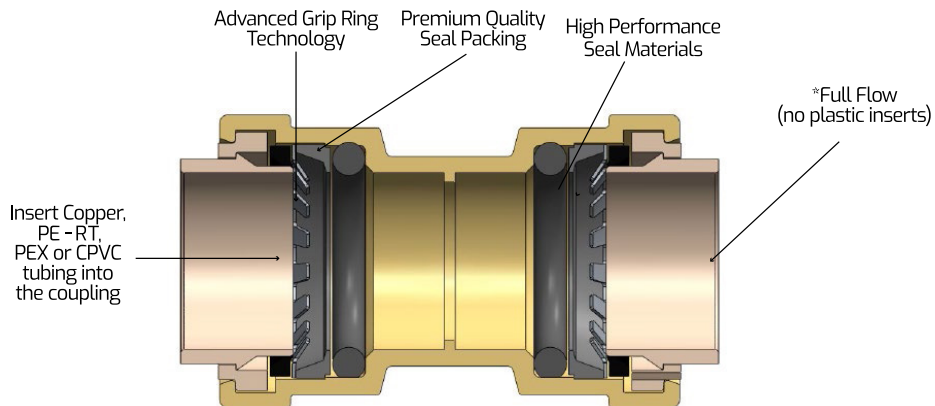

75
YEAR
WARRANTY

*When using PEX or PE-RT, a Hi-Flo tube stiffener should be inserted into the tubing end prior to insertion into the fitting or valve.

PIPE AND TUBING

Use For Copper, PEX, PE-RT & CPVC Tubing

QuickFitting fittings have been tested to ASSE 1061/NSF 61/NSF 372 standards and are listed by IAPMO, meeting UPC, IPC and cUPC requirements.

APPLICATIONS

Fluids, Inert Gases, Water & Air

QuickFitting fittings are certified for potable and hydronic heating installations, as well as underground applications and as a plumbing joint without access panels.

ASSORTMENT

Wide Variety of Fittings, Kits & Valves

QuickFitting offers a wide range of push connect plumbing fittings, as well as stop valves, ball valves, gate valves, installation kits and custom products.

EASY INSTALL, EASY APPLICATION
JUST PUSH TO CONNECT

1 CUT IT
 Cut your copper, PEX, PE-RT, or CPVC tubing using a sharp tubing cutter.

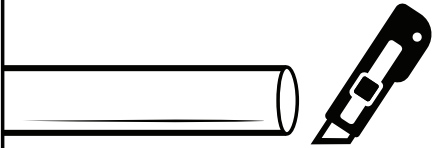

1. Corte la tubería usando un recortador afilado.

2 CLEAN IT
 Clean the tubing, and use a deburring tool to ensure proper connection.



2. Limpie y quite las rebabas de la tubería.

3 MARK IT
 Mark the insertion depth on the tubing to ensure proper insertion.



3. Marque la profundidad de inserción.

4 PUSH IT
 Push the fitting or valve to meet the insertion depth mark...you're done.
*Use a hi-flo stiffener on PEX & PE-RT tubing only

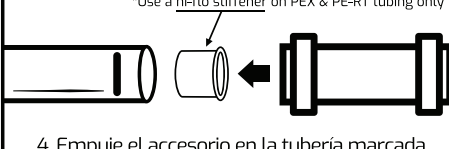

4. Empuje el accesorio en la tubería marcada.
*Use un refuerzo hi-flo para tubería de PEX y PE-RT

PATENTED SLIP CLIP™ RELEASE TOOL

QuickFitting push technology features a more secure connection than standard fittings, all while giving the user full control through our patented smart release tool.

With our patented Slip Clip release tool, you can easily remove, reposition, and reuse our technology.

We offer an extensive selection of SKUs in our brass push fitting technology. Both professionals and do-it-yourselfers will find the right solution for their plumbing requirements with QuickFitting. You just can't beat advanced patented technology, extensive selection, premium quality and superior value proposition.



SLIP CLIP RELEASE TOOL
 Herramienta de remoción

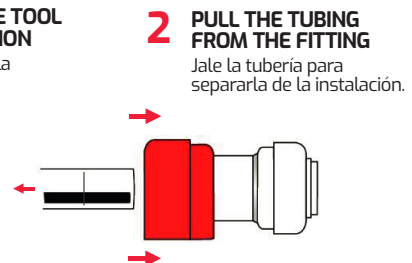
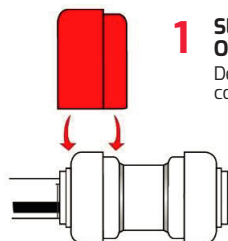
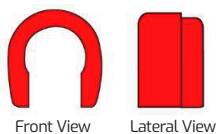



QUICKFITTING[®]
STAINLESS STEEL

PRODUCT LISTING

QUICKFITTING[®]

STAINLESS STEEL

The QuickFitting Stainless Steel push fittings product line delivers the same patented design with superior sealing performance but raises the bar for the industry with a 100% lead-free professional grade 304 stainless steel body. These premium fittings offer the best corrosion resistance and are available in larger sizes (1-1/4" – 2").



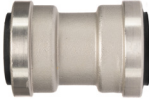

COUPLING	PART #	PRODUCT DESCRIPTION	BOX QTY.	CASE QTY.
	SS811R	1/2" x 1/2" Straight Coupling	40	240
	SS821R	3/4" x 3/4" Straight Coupling	25	150
	SS831R	1" x 1" Straight Coupling	20	120
	SS851R	1-1/4" x 1-1/4" Straight Coupling	8	48
	SS861R	1-1/2" x 1-1/2" Straight Coupling	4	24
	SS871R	2" x 2" Straight Coupling	3	18
	SS841R	3/4" x 1/2" Reducing Coupling	30	180
	SS817R	1/2" x 1/2" Repair Coupling	20	120
	SS827R	3/4" x 3/4" Repair Coupling	12	72

FEMALE STRAIGHT ADAPTER	PART #	PRODUCT DESCRIPTION	BOX QTY.	CASE QTY.
	SS812FR	1/2" x 1/2" FNPT Straight Female Adapter	40	240
	SS822FR	3/4" x 3/4" FNPT Straight Female Adapter	30	180
	SS832FR	1" x 1" FNPT Straight Female Adapter	25	150
	SS852FR	1-1/4" x 1-1/4" FNPT Straight Female Adapter	10	60
	SS862FR	1-1/2" x 1-1/2" FNPT Straight Female Adapter	6	36
	SS872FR	2" x 2" FNPT Straight Female Adapter	5	30
	SS842FR	1/2" x 3/4" FNPT Straight Female Adapter	30	180

QUICKFITTING®

STAINLESS STEEL

MALE STRAIGHT ADAPTER	PART #	PRODUCT DESCRIPTION	BOX QTY.	CASE QTY.
	SS812MR	1/2" x 1/2" MNPT Straight Male Adapter	40	240
	SS822MR	3/4" x 3/4" MNPT Straight Male Adapter	30	180
	SS832MR	1" x 1" MNPT Straight Male Adapter	25	150
	SS852MR	1-1/4" x 1-1/4" MNPT Straight Male Adapter	10	60
	SS862MR	1-1/2" x 1-1/2" MNPT Straight Male Adapter	6	36
	SS872MR	2" x 2" MNPT Straight Male Adapter	5	30

ELBOW	PART #	PRODUCT DESCRIPTION	BOX QTY.	CASE QTY.
	SS813R	1/2" x 1/2" Elbow	30	180
	SS823R	3/4" x 3/4" Elbow	20	120
	SS833R	1" x 1" Elbow	15	90
	SS853R	1-1/4" x 1-1/4" Elbow	6	36
	SS863R	1-1/2" x 1-1/2" Elbow	4	24
	SS873R	2" x 2" Elbow	2	12
	SS813FR	1/2" x 1/2" FNPT Elbow	40	240
	SS823FR	3/4" x 3/4" FNPT Elbow	25	150
	SS813MR	1/2" x 1/2" MNPT Elbow	40	240
	SS823MR	3/4" x 3/4" MNPT Elbow	25	150
	SS843R	3/4" x 1/2" Elbow	25	150

TEE	PART #	PRODUCT DESCRIPTION	BOX QTY.	CASE QTY.
	SS814R	1/2" x 1/2" x 1/2" Tee	25	150
	SS824R	3/4" x 3/4" x 3/4" Tee	15	90
	SS834R	1" x 1" x 1" Tee	10	60
	SS854R	1-1/4" x 1-1/4" x 1-1/4" Tee	4	24
	SS864R	1-1/2" x 1-1/2" x 1-1/2" Tee	2	12
	SS874R	2" x 2" x 2" Tee	1	6
	SS815R	3/4" x 1/2" x 1/2" Reducing Tee	15	90
	SS825R	3/4" x 1/2" x 3/4" Reducing Tee	15	90
	SS844R	3/4" x 3/4" x 1/2" Reducing Tee	15	90
	SS835R	1" x 1" x 3/4" Reducing Tee	10	60

QUICKFITTING®

STAINLESS STEEL

CAP	PART #	PRODUCT DESCRIPTION	BOX QTY.	CASE QTY.
	SS816R	1/2" End Stop	50	300
	SS826R	3/4" End Stop	40	240
	SS836R	1" End Stop	30	180
	SS856R	1-1/4" End Stop	15	90
	SS866R	1-1/2" End Stop	9	54
	SS876R	2" End Stop	7	42

BALL VALVE	PART #	PRODUCT DESCRIPTION	BOX QTY.	CASE QTY.
	SS912R	1/2" x 1/2" Full Port Ball Valve	25	150
	SS922R	3/4" x 3/4" Full Port Ball Valve	12	72
	SS932R	1" x 1" Full Port Ball Valve	10	60
	SS952R	1-1/4" x 1-1/4" Full Port Ball Valve	1	1
	SS962R	1-1/2" x 1-1/2" Full Port Ball Valve	1	1
	SS972R	2" x 2" Full Port Ball Valve	1	1

SLIP CLIP™ RELEASE TOOL	PART #	PRODUCT DESCRIPTION	BOX QTY.	CASE QTY.
	PP711R	1/2" Patented Slip Clip™ Release Tool	35	210
	PP721R	3/4" Patented Slip Clip™ Release Tool	25	150
	PP731R	1" Patented Slip Clip™ Release Tool	20	120
	PP771R	1-1/4" Patented Slip Clip™ Release Tool	10	60
	PP781R	1-1/2" Patented Slip Clip™ Release Tool	8	48
	PP791R	2" Patented Slip Clip™ Release Tool	6	36

STIFFENER	PART #	PRODUCT DESCRIPTION	BOX QTY.	CASE QTY.
	PB712R	1/2" Tube Stiffener, Hi-Flo (Bag of 10)	100	N/A
	PB722R	3/4" Tube Stiffener, Hi-Flo (Bag of 10)	100	N/A
	PB732R	1" Tube Stiffener, Hi-Flo (Bag of 10)	100	N/A
	PB752R	1-1/4" Tube Stiffener, Hi-Flo (Bag of 2)	100	N/A
	PB762R	1-1/2" Tube Stiffener, Hi-Flo (Bag of 2)	100	N/A
	PB772R	2" Tube Stiffener, Hi-Flo (Bag of 2)	100	N/A



QUICKFITTING[®]
BRASS

PRODUCT LISTING

QUICKFITTING[®] BRASS

QuickFitting Brass delivers superior proven technology, premium quality, significant value – as well as the widest assortment of any competitive push fit brand.

Our lead-free and safe brass alternative push fit technology, provides users with technology that not only protects your health – but their affordability and smart technology protects your time & your wallet, too.



COUPLING	PART #	PRODUCT DESCRIPTION	BOX QTY.	CASE QTY.
	LF881R	1/4" x 1/4" Straight Coupling	50	300
	LF801R	3/8" x 3/8" Straight Coupling	50	300
	LF811R	1/2" x 1/2" Straight Coupling	40	240
	LF821R	3/4" x 3/4" Straight Coupling	25	150
	LF831R	1" x 1" Straight Coupling	20	120

REDUCING COUPLING	PART #	PRODUCT DESCRIPTION	BOX QTY.	CASE QTY.
	LF8401R	3/8" x 1/2" Reducing Coupling	50	300
	LF8408R	3/8" x 1/4" Reducing Coupling	50	300
	LF841R	3/4" x 1/2" Reducing Coupling	30	180
	LF8413R	1" x 3/4" Reducing Coupling	20	120

SLIP REPAIR COUPLING	PART #	PRODUCT DESCRIPTION	BOX QTY.	CASE QTY.
	LF817R	1/2" x 1/2" Repair Coupling	30	180
	LF827R	3/4" x 3/4" Repair Coupling	20	120
	LF837R	1" x 1" Repair Coupling	10	60

TRANSITION COUPLING	PART #	PRODUCT DESCRIPTION	BOX QTY.	CASE QTY.
	LF811PBYR	1/2" x 1/2" Polybutylene Transition Coupling	40	240
	LF821PBYR	3/4" x 3/4" Polybutylene Transition Coupling	25	150

QUICKFITTING®

BRASS

FEMALE STRAIGHT ADAPTER	PART #	PRODUCT DESCRIPTION	BOX QTY.	CASE QTY.
	LF882FR	1/4" x 1/4" FNPT Straight Female Adapter	50	300
	LF802FR	3/8" x 3/8" FNPT Straight Female Adapter	50	300
	LF812FR	1/2" x 1/2" FNPT Straight Female Adapter	40	240
	LF822FR	3/4" x 3/4" FNPT Straight Female Adapter	30	180
	LF832FR	1" x 1" FNPT Straight Female Adapter	25	150

FEMALE STRAIGHT REDUCING ADAPTER	PART #	PRODUCT DESCRIPTION	BOX QTY.	CASE QTY.
	LF840FR	3/8" x 1/2" FNPT Straight Female Adapter	50	300
	LF842FR	1/2" x 3/4" FNPT Straight Female Adapter	30	180
	LF8322FR	1" x 3/4" FNPT Straight Female Adapter	25	150

MALE STRAIGHT ADAPTER	PART #	PRODUCT DESCRIPTION	BOX QTY.	CASE QTY.
	LF882MR	1/4" x 1/4" MNPT Straight Male Adapter	50	300
	LF802MR	3/8" x 3/8" MNPT Straight Male Adapter	50	300
	LF812MR	1/2" x 1/2" MNPT Straight Male Adapter	40	240
	LF822MR	3/4" x 3/4" MNPT Straight Male Adapter	30	180
	LF832MR	1" x 1" MNPT Straight Male Adapter	25	150

MALE STRAIGHT REDUCING ADAPTER	PART #	PRODUCT DESCRIPTION	BOX QTY.	CASE QTY.
	LF840MR	3/8" x 1/2" MNPT Straight Male Adapter	50	300
	LF842MR	1/2" x 3/4" MNPT Straight Male Adapter	30	180
	LF8233MR	3/4" x 1" MNPT Straight Male Adapter	25	150
	LF8322MR	1" x 3/4" MNPT Straight Male Adapter	25	150

CTS ADAPTER	PART #	PRODUCT DESCRIPTION	BOX QTY.	CASE QTY.
	LF8338R	1/2" CTS x 3/8" Push Reducing Coupling	30	180
	LF8348R	3/4" CTS x 3/8" Push Reducing Coupling	30	180
	LF8138R	1" CTS x 1/2" Push Reducing Coupling	20	120
	LF8238R	1" CTS x 3/4" Push Reducing Coupling	20	120
	LF8228R	3/4" CTS x 3/4" FNPT, Water Heater Adapter	30	180

QUICKFITTING®

BRASS

ELBOW	PART #	PRODUCT DESCRIPTION	BOX QTY.	CASE QTY.
	LF883R	1/4" x 1/4" Elbow	50	300
	LF803R	3/8" x 3/8" Elbow	40	240
	LF813R	1/2" x 1/2" Elbow	30	180
	LF823R	3/4" x 3/4" Elbow	25	150
	LF833R	1" x 1" Elbow	15	90

FEMALE ELBOW ADAPTER	PART #	PRODUCT DESCRIPTION	BOX QTY.	CASE QTY.
	LF803FR	3/8" x 3/8" FNPT Elbow	50	300
	LF813FR	1/2" x 1/2" FNPT Elbow	40	240
	LF823FR	3/4" x 3/4" FNPT Elbow	25	150

MALE ELBOW ADAPTER	PART #	PRODUCT DESCRIPTION	BOX QTY.	CASE QTY.
	LF803MR	3/8" x 3/8" MNPT Elbow	50	300
	LF813MR	1/2" x 1/2" MNPT Elbow	40	240
	LF823MR	3/4" x 3/4" MNPT Elbow	25	150

REDUCING ELBOW	PART #	PRODUCT DESCRIPTION	BOX QTY.	CASE QTY.
	LF843R	3/4" x 1/2" Elbow	25	150
	LF8343R	1" x 3/4" Reducing Elbow	15	90

DROP EAR ELBOW	PART #	PRODUCT DESCRIPTION	BOX QTY.	CASE QTY.
	LF803DR	3/8" x 3/8" FNPT Elbow Drop Ear	40	240
	LF800DR	3/8" x 1/2" FNPT Elbow Drop Ear	30	180
	LF810DR	1/2" x 1/2" Elbow Drop Ear	30	180
	LF813DR	1/2" x 1/2" FNPT Elbow Drop Ear	30	180
	LF820DR	3/4" x 3/4" FNPT Elbow Drop Ear	20	120
	LF810FHR	1/2" x 1/2" FNPT Elbow Hy-Ear	30	180

QUICKFITTING®

BRASS

EQUAL TEE	PART #	PRODUCT DESCRIPTION	BOX QTY.	CASE QTY.
	LF884R	1/4" x 1/4" x 1/4" Tee	40	240
	LF804R	3/8" x 3/8" x 3/8" Tee	30	180
	LF814R	1/2" x 1/2" x 1/2" Tee	25	150
	LF824R	3/4" x 3/4" x 3/4" Tee	15	90
	LF834R	1" x 1" x 1" Tee	10	60

TEE	PART #	PRODUCT DESCRIPTION	BOX QTY.	CASE QTY.
	LF8024R	3/8" x 3/8" x 1/2" Reducing Tee	30	180
	LF8014R	1/2" x 1/2" x 3/8" Reducing Tee	30	180
	LF815R	3/4" x 1/2" x 1/2" Reducing Tee	15	90
	LF825R	3/4" x 1/2" x 3/4" Reducing Tee	15	90
	LF844R	3/4" x 3/4" x 1/2" Reducing Tee	15	90
	LF835R	1" x 1" x 3/4" Reducing Tee	10	60
	LF8147R	1/2" x 1/2" x 1/2" Slip Tee	15	90
	LF8247R	3/4" x 3/4" x 3/4" Slip Tee	10	60
	LF8147FR	1/2" x 1/2" x 1/2" FNPT Slip Tee	15	90
	LF8247FR	3/4" x 3/4" x 3/4" FNPT Slip Tee	10	60
	LF824FR	3/4" x 3/4" x 3/4" FNPT Tee	15	90
	LF834FR	1" x 1" x 1" FNPT Tee	10	60

CAP	PART #	PRODUCT DESCRIPTION	BOX QTY.	CASE QTY.
	LF886R	1/4" End Stop	60	360
	LF806R	3/8" End Stop	60	360
	LF816R	1/2" End Stop	50	300
	LF826R	3/4" End Stop	40	240
	LF836R	1" End Stop	30	180

QUICKFITTING®

BRASS

BALL VALVE	PART #	PRODUCT DESCRIPTION	BOX QTY.	CASE QTY.
	LF902R	3/8" x 3/8" Full Port Ball Valve	30	180
	LF912R	1/2" x 1/2" Full Port Ball Valve	25	150
	LF922R	3/4" x 3/4" Full Port Ball Valve	15	90
	LF922FR	3/4" x 3/4" FNPT Full Port Ball Valve	15	90
	LF932R	1" x 1" Full Port Ball Valve	10	60
	LF922DR	3/4" x 3/4" Full Port Valve w/ Drain	15	90

CHECK VALVE	PART #	PRODUCT DESCRIPTION	BOX QTY.	CASE QTY.
	LF917R	1/2" Check Valve	30	180
	LF927R	3/4" Check Valve	20	120
	LF937R	1" Check Valve	15	90

FAUCET CONNECTOR	PART #	PRODUCT DESCRIPTION	BOX QTY.	CASE QTY.
	LF746SR	1/2" Straight Valve x 1/2" FIP, 12" Faucet Connector Hose, EPDM Seal	10	N/A
	LF745SR	1/2" Straight Valve x 1/2" FIP, 18" Faucet Connector Hose, EPDM Seal	10	N/A
	LF747SR	1/2" Push Straight Valve x 1/2" FIP, 24" Faucet Connector Hose, EPDM Seal	10	N/A
	LF746AR	1/2" Push Angle Valve x 1/2" FIP x 12" Faucet Connector Hose, EPDM Seal	10	N/A
	LF745AR	1/2" Push Angle Valve x 1/2" FIP x 18" Faucet Connector Hose, EPDM Seal	10	N/A
	LF747AR	1/2" Push Angle Valve x 1/2" FIP x 24" Faucet Connector Hose, EPDM Seal	10	N/A

TOILET CONNECTOR	PART #	PRODUCT DESCRIPTION	BOX QTY.	CASE QTY.
	LF756SR	1/2" Straight Valve x 7/8" Plastic Female, 12" Toilet Connect Hose	10	N/A
	LF755SR	1/2" Straight Valve x 7/8" Plastic Female, 18" Toilet Connect Hose	10	N/A
	LF756AR	1/2" Angle Valve x 7/8" Plastic Female, 12" Toilet Connect Hose	10	N/A
	LF755AR	1/2" Angle Valve x 7/8" Plastic Female, 18" Toilet Connect Hose	10	N/A

QUICKFITTING®

BRASS

WATER HEATER CONNECTOR	PART #	PRODUCT DESCRIPTION	BOX QTY.	CASE QTY.
	LF7125FR	1/2" PF x 3/4" FIP, 18" Stainless Steel Braided Water Heater Hose	10	N/A
	LF725FR	3/4" PF x 3/4" FIP, 18" Stainless Steel Braided Water Heater Hose, EPDM Seal	10	N/A
	LF726FPR	3/4" PF x 3/4" FIP Full Port 12" Stainless Steel Braided Water Heater Hose	10	N/A
	LF725FPR	3/4" PF x 3/4" FIP Full Port 18" Stainless Steel Braided Water Heater Hose	10	N/A
	LF727FPR	3/4" PF x 3/4" FIP Full Port 24" Stainless Steel Braided Water Heater hose	10	N/A
	LF725PR	3/4" PF x 3/4" FIP, Full Port 18" Stainless Steel Braided Water Heater Hose	10	N/A
	LF7245FR	3/4" PF Ball Valve x 3/4" FIP 18" Stainless Steel Braided Water Heater Hose	10	N/A
	LF7245FPR	3/4" PF Ball Valve x 3/4" FIP, Full Port 18" Stainless Steel Braided Water Heater Hose	10	N/A
	LF7128KR	1/2" PF x 3/4" FNPT Water Heater Installation Kit: Includes (2) LFB42FR & (1) PP711R	20	120
	LF718KR	1/2" PF x 1/2" FNPT Water Heater Installation Kit: Includes (2) LFB12FR & (1) PP711R	30	180
	LF728KR	3/4" PF x 3/4" FNPT Water Heater Installation Kit: Includes (2) LFB22FR & (1) PP721R	20	120

REPAIR HOSE	PART #	PRODUCT DESCRIPTION	BOX QTY.	CASE QTY.
	LF716R	1/2" PF x 1/2" PF, 12" SST Repair Hose	10	N/A
	LF715R	1/2" PF x 1/2" PF, 18" SST Repair Hose	10	N/A
	LF726R	3/4" PF x 3/4" PF, 12" SST Repair Hose	10	N/A
	LF725R	3/4" PF x 3/4" PF, 18" SST Repair Hose	10	N/A
	LF716FR	1/2" PF x 1/2" FIP, 12" SST Repair Hose	10	N/A
	LF715FR	1/2" PF x 1/2" FIP, 18" SST Repair Hose	10	N/A
	LF717FR	1/2" PF x 1/2" FIP, 24" SST Repair Hose	10	N/A

STOP VALVE	PART #	PRODUCT DESCRIPTION	BOX QTY.	CASE QTY.
	LF944AR	1/2" x 1/4" OD. Chrome Plated, 1/4 Turn Angle Stop Valve	30	180
	LF944SR	1/2" x 1/4" OD. Chrome Plated, 1/4 Turn Straight Stop Valve	30	180
	LF953AR	1/2" x 3/8" OD. Chrome Plated, 1/4 Turn Angle Stop Valve	30	180
	LF953SR	1/2" x 3/8" OD. Chrome Plated, 1/4 Turn Straight Stop Valve	30	180
	LF944TR	1/2" x 1/2" x 1/4" OD Comp., 3-way, Chrome Plated 1/4 Turn Stop Valve Tee	30	180
	LF954TR	1/2" x 1/2" x 3/8" OD Comp., 3-way, Chrome Plated 1/4 Turn Stop Valve Tee	30	180
	LF914TR	1/2" x 3/8" OD Comp. x 3/8" OD Comp., 3-way, Chrome Plated 1/4 Turn Stop Valve Tee	30	180
	LF9745R	1/2" x 5/8" OD. Chrome Plated, 1/4 Turn Straight Stop Valve	30	180
	LF914R	1/2" x 1/2", 1/4 Turn Straight Stop Valve	30	180

QUICKFITTING[®]

BRASS

SLIP CLIP™ RELEASE TOOL	PART #	PRODUCT DESCRIPTION	BOX QTY.	CASE QTY.
	PP711R	1/2" Patented Slip Clip™ Release Tool	35	210
	PP721R	3/4" Patented Slip Clip™ Release Tool	25	150
	PP731R	1" Patented Slip Clip™ Release Tool	20	120

DISCONNECT TOOL	PART #	PRODUCT DESCRIPTION	BOX QTY.	CASE QTY.
	PB741R	1/4" Disconnect Tool	100	600
	PB701R	3/8" Disconnect Tool	100	600

STIFFENER	PART #	PRODUCT DESCRIPTION	BOX QTY.	CASE QTY.
	PB702R	3/8" Tube Stiffener, Hi-Flo (Bag of 10)	100	N/A
	PB712R	1/2" Tube Stiffener, Hi-Flo (Bag of 10)	100	N/A
	PB722R	3/4" Tube Stiffener, Hi-Flo (Bag of 10)	100	N/A
	PB732R	1" Tube Stiffener, Hi-Flo (Bag of 10)	100	N/A



QUICKFITTING[®]
COPPER

PRODUCT LISTING

QUICKFITTING[®]

COPPER

Copper is well known for its strength and superior heat transfer properties in plumbing applications.

In addition to being lead-free and having no arsenic additives, our 99.97% copper push fittings and valves are certified "lead free" by NSF and are certified as meeting the stringent requirements of the California AB 1953 Lead Law. They are dezincification resistant, and the high-performance seals used in our push fit products are certified Chloramine resistant.



COUPLING	PART #	PRODUCT DESCRIPTION	BOX QTY.	CASE QTY.
	CH811R	1/2" x 1/2" Straight Coupling	40	240
	CH821R	3/4" x 3/4" Straight Coupling	25	150
	CH831R	1" x 1" Straight Coupling	20	120
	CH841R	3/4" x 1/2" Reducing Coupling	30	180
	CH8413R	1" x 3/4" Reducing Coupling	20	120

SLIP REPAIR COUPLING	PART #	PRODUCT DESCRIPTION	BOX QTY.	CASE QTY.
	CH817R	1/2" x 1/2" Repair Coupling	30	180
	CH827R	3/4" x 3/4" Repair Coupling	20	120
	CH837R	1" x 1" Repair Coupling	10	60

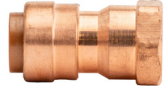
FEMALE STRAIGHT ADAPTER	PART #	PRODUCT DESCRIPTION	BOX QTY.	CASE QTY.
	CH812FR	1/2" x 1/2" FNPT Straight Female Adapter	40	240
	CH822FR	3/4" x 3/4" FNPT Straight Female Adapter	30	180
	CH832FR	1" x 1" FNPT Straight Female Adapter	25	150

QUICKFITTING®

COPPER

FEMALE STRAIGHT REDUCING ADAPTER	PART #	PRODUCT DESCRIPTION	BOX QTY.	CASE QTY.
	CH842FR	1/2" x 3/4" FNPT Straight Female Adapter	30	180
	CH8322FR	1" x 3/4" FNPT Straight Female Adapter	25	150

MALE STRAIGHT ADAPTER	PART #	PRODUCT DESCRIPTION	BOX QTY.	CASE QTY.
	CH812MR	1/2" x 1/2" MNPT Straight Male Adapter	40	240
	CH822MR	3/4" x 3/4" MNPT Straight Male Adapter	30	180
	CH832MR	1" x 1" MNPT Straight Male Adapter	25	150

MALE STRAIGHT REDUCING ADAPTER	PART #	PRODUCT DESCRIPTION	BOX QTY.	CASE QTY.
	CH842MR	1/2" x 3/4" MNPT Straight Male Adapter	30	180
	CH8322MR	1" x 3/4" MNPT Straight Male Adapter	25	150

ELBOW	PART #	PRODUCT DESCRIPTION	BOX QTY.	CASE QTY.
	CH813R	1/2" x 1/2" Elbow	30	180
	CH823R	3/4" x 3/4" Elbow	25	150
	CH833R	1" x 1" Elbow	15	90
	CH813FR	1/2" x 1/2" FNPT Elbow	40	240
	CH813MR	1/2" x 1/2" MNPT Elbow	40	240
	CH823FR	3/4" x 3/4" FNPT Elbow	25	150
	CH823MR	3/4" x 3/4" MNPT Elbow	25	150
	CH813STR	1/2" 90° Degree Elbow Street	30	180
	CH823STR	3/4" 90° Degree Elbow Street	25	150
	CH843R	3/4" x 1/2" Reducing Elbow	25	150
	CH8343R	1" x 3/4" Reducing Elbow	15	90

45 ELBOW	PART #	PRODUCT DESCRIPTION	BOX QTY.	CASE QTY.
	CH8134R	1/2" x 1/2" 45° Elbow	30	180
	CH8234R	3/4" x 3/4" 45° Elbow	25	150
	CH8334R	1" X 1" 45° Elbow	15	90
	CH81345STR	1/2" 45° Degree Elbow Street	30	180
	CH82345STR	3/4" 45° Degree Elbow Street	25	150

QUICKFITTING[®]

COPPER

TEE	PART #	PRODUCT DESCRIPTION	BOX QTY.	CASE QTY.
	CH814R	1/2" x 1/2" x 1/2" Tee	25	150
	CH824R	3/4" x 3/4" x 3/4" Tee	15	90
	CH834R	1" x 1" x 1" Tee	10	60

REDUCING TEE	PART #	PRODUCT DESCRIPTION	BOX QTY.	CASE QTY.
	CH815R	3/4" x 1/2" x 1/2" Reducing Tee	15	90
	CH825R	3/4" x 1/2" x 3/4" Reducing Tee	15	90
	CH844R	3/4" x 3/4" x 1/2" Reducing Tee	15	90

CAP	PART #	PRODUCT DESCRIPTION	BOX QTY.	CASE QTY.
	CH816R	1/2" End Stop	50	300
	CH826R	3/4" End Stop	40	240
	CH836R	1" End Stop	30	180

SLIP CLIP™ RELEASE TOOL	PART #	PRODUCT DESCRIPTION	BOX QTY.	CASE QTY.
	CHRT050R	1/2" Patented Slip Clip™ Release Tool	35	210
	CHRT075R	3/4" Patented Slip Clip™ Release Tool	25	150
	CHRT100R	1" Patented Slip Clip™ Release Tool	20	120

STIFFENER	PART #	PRODUCT DESCRIPTION	BOX QTY.	CASE QTY.
	PB712R	1/2" Tube Stiffener, Hi-Flo (Bag of 10)	100	N/A
	PB722R	3/4" Tube Stiffener, Hi-Flo (Bag of 10)	100	N/A
	PB732R	1" Tube Stiffener, Hi-Flo (Bag of 10)	100	N/A



QUICKFITTING[®]

ADDITIONAL INFORMATION



FREQUENTLY ASKED QUESTIONS

Joining Copper, PEX, PE-RT or CPVC Tubing

Q: Do I need to prepare the tube ends differently when using push fittings?

A: No, as with sweat copper fittings, the tube must be chamfered, de-burred and reamed (free from burrs and debris). QuickFitting recommends the use of an Inner/Outer Reamer to chamfer, de-burr and ream tube ends. These steps are essential to ensure the proper connection of your push-to-connect fitting. Also, be sure to draw an insertion mark on the tube to indicate the proper insertion of the tubing into the fitting.

Q: What types of tubing can be used with QuickFitting push to connect fittings?

A: QuickFitting connectors are approved for use with Copper, PE-RT, CPVC and PEX.

Q: Should I use a tubing insert stiffener on Copper, PE-RT, PEX and CPVC?

A: A stiffener is only required when connecting PEX tubing.

Q: Should I pressure test my system following the installation of push fittings?

A: Yes, as with all types of plumbing fittings, new installations should be pressure tested to ensure a proper connection.

Q: Can I install push fittings in a wet (charged) system?

A: Push fittings can be installed wet or dry. System pressures should be relieved to avoid injury prior to installation.

Installing, Testing and Flushing Your Push Fit System

Q: Can our Fittings blow off a water system?

A: NO, the grip ring technology utilizes an opposing force principle, which simply put, the higher the force used to pull the fitting, the deeper the fitting bites into the tubing.

Q: What pressure/temperature have our fittings been tested to withstand?

A: QuickFitting push to connect fittings are tensile tested to over 900-pound force and temperatures up to 200 °F.

Q: What support hanger spacing must I use with my QuickFitting system?

A: Support requirements are identical to a sweat system; as such installers should adhere to local codes. Always fully support heavy loads on your plumbing system.

Q: How do I test my QuickFitting system?

A: Pressure testing should be conducted the same way as you would with a Copper sweat system. The system should be installed, pressurized and then held under pressure for a period determined by your local plumbing regulations.

Q: Do I need to lubricate the fitting when installing?

A: No, QuickFitting seals are factory-lubricated with an NSF-61 approved lubricant.

Q: Do I still have to flush my system with water?

A: Yes, but the system will be cleaner and flush faster since there is no solder or flux.

Q: Should I use glue or solder when installing QuickFitting?

A: Glues, adhesives or sealants are not required and should never be applied to the connection, fitting or tubing.

Q: Are QuickFitting push to connect fittings approved for underground burial?

A: Yes, our fittings are tested and approved for underground burial and in-wall use. We recommend wrapping the connection in a waterproof tape to avoid aggressive chemicals that may exist in the soil.



System

1.1 The fittings and valves shall be of the push to connect type (Manufacturer - Quick Fitting Holding Co.) and shall be manufactured to the quality system of ISO 9001.

1.2 The system shall be full bore passage without diameter restriction for the fittings, in order to avoid high pressure-drop.

Pipe

2.1 Copper pipe shall conform to ASTM B-88 and may be type K, L, or M seamless copper.

2.2 CPVC pipe shall conform to ASTM D2846, CSA B137.6.

2.3 PEX tubing shall conform to ASTM F-876, CSA B137.5. Tube support liners provided by QuickFitting shall be used.

2.4 Plumbing systems must be installed in compliance with local plumbing code.

Fittings & Valves

3.1 Fittings and valves shall have a maximum operating pressure of 200 PSI at a maximum continuous operating temperature of 200°F. Higher temperatures and pressures may be permissible; please consult with manufacturer.

3.2 Fittings shall utilize copper alloy bodies meeting ASTM B-283 standard with stainless steel gripping teeth and shall use EPDM seals that are certified to NSF-61 service.

3.3 Fittings and valves shall incorporate a one-step connection method: push-to-connect, no pre-lubrication required.

3.4 Fittings and valves shall permit 360° rotation of the pipe while system is depressurized.

3.5 Fittings and valves shall be removable and reusable with the use of a removal tool (Manufacturer - Quick Fitting Holding Co.)

3.6 Fittings shall use NSF/ANSI/CAN 61-2020 and NSF/ANSI/CAN 372-2020 approved pre-lubricated EPDM seals so that additional lubrication or fitting preparation is not needed.

3.7 Fittings shall be design certified to ASSE-1061, NSF/ANSI/CAN 61-2020, and NSF/ANSI/CAN 372-2020.

System Installation

4.1 Fittings shall be installed according to QuickFitting installation instructions.

4.2 Pipe ends shall be chamfered, de-burred, reamed, and depth marked prior to fitting or valve installation. When cutting tubing, ensure that the ends are cut square and are free of burrs.

4.3 Ensure that there are no scratches, gouges or any form of damage on the circumference of the tube within the specified depth on Table 1.1. Damage in this area may cause leakage. Check the fitting for any signs of damage or foreign objects. Push the QuickFitting fitting or valve onto the end of the copper pipe until depth mark is covered.

Insertion Depth Table

Fitting Size	1/4"	3/8"	1/2"	3/4"	1"	1 1/4"	1 1/2"	2"
Depth	3/4"	3/4"	1"	1-3/16"	1-3/16"	1-7/8"	2-1/8"	2-3/16"

4.4 Use only in accordance with QuickFitting's specifications and operating instructions.

4.5 If PEX tubing is used, then a tube support liner must be used also. The tube support liner acts as an internal support for the end of the tubing.

4.6 When a joint has to be disassembled and then re-used, ensure that the tubing removed from the joint has no damage on the circumference within the specified depth on Table 1.1. Inspect the tube and connection for any signs of damage and ensure they are free of foreign materials. The joint can then be reassembled.

4.7 Installations shall be pressure tested to ensure proper insertion of the push fittings and valves.

4.8 Installers shall never use pliers or crush the push connect head of the fitting.

QUICKFITTING®

RETAIL AND/OR WHOLESALE PACKAGING

QuickFitting UPC bar-coded retail and private label packaging is available. Consult our Retail Pricing guide or a QuickFitting representative at **(877) 238-4826** for more information.

MINIMUM ORDER SIZE

Minimum net order value is \$75.00.



PRODUCT RETURN POLICY

Purchasers wanting to return items for credit may do so under the following conditions:

1. All returns require a Return Goods Authorization (RGA) number, which is active for 30 days from the date of issue. Contact QuickFitting's Customer Service RGA assistance. Returned items must have the RGA# clearly visible on the outside of the package, along with any related documents or they cannot be accepted.
2. All inventory returns for credit must be received no later than the ninth month of the calendar year and the credit will be issued only to the original purchaser.
3. Private label and soft private branded products are not returnable for credit.
4. A 25% restocking charge will apply to all returns.
5. All returned items must be returned in their original packaging. Returned items must be complete with all manuals, documentation, etc. Acceptable returns must be in their original packaging, unused, free from defects or scarring and be current, non-obsolete product.
6. Returns must be made within 100 days of the date indicated on the original Purchase Order.
7. Custom items may not be returned for credit.
8. Products must be shipped back to QuickFitting freight prepaid. QuickFitting will not be responsible for any freight charges, duties, or fees and no credit will be given for them. Returns should include a Return Goods Authorization (RGA) number and be addressed to:

Quick Fitting Holding Company, LLC.
Attn: Return Goods, [Your RGA #]
655 Waterman Ave., East Providence, RI 02914

9. Returns not meeting the above terms and conditions will be rejected and either returned to sender or disposed of at the senders written direction.

QuickFitting will not be responsible for inventory returns that are lost or damaged during the transportation of the inventory to our facility. The original shipper should insure all returns to the full value of the return.

PAYMENT TERMS

All invoices are due upon receipt, unless credit terms have been established.

Billing Address: Quick Fitting Holding Company, LLC, P.O. Box 70167, Houston, TX 77270.



WARRANTY INFORMATION

UP TO 75 YEAR QUICKFITTING PRODUCT WARRANTY

Quick Fitting Holding Company, LLC. hereafter referred to as "QuickFitting", warrants its QuickFitting fittings and adapters to be free of defects in material and workmanship in water service and other approved materials, for a period of seventy-five (75) years from the date of purchase of the products. QuickFitting makes no other warranties, express or implied. This limitation explicitly excludes any implied warranty of merchantability or fitness for a particular purpose. The sole remedy for breach of this warranty of material and workmanship or for negligence in manufacture or design is limited to replacement or repair of the fitting, at the sole option of QuickFitting, of any defective parts which are returned to QuickFitting (prepaid) within seventy-five (75) years of original purchase. QuickFitting fittings contain a replaceable O-ring seal, which is warranted for replacement in water service for a period of (75) seventy-five years. In no event shall QuickFitting be liable for indirect, special, incidental or consequential damages of any kind. No allowance will be made for repairs made by the purchaser.

VALVE & CONTROL WARRANTY

Supplier warrants its QuickFitting push fit ball valves, stop valves and controls to be free of defects in material and workmanship in water service and other approved materials, for a period of seven (7) years from the date of purchase of the products. Supplier makes no other warranties, express or implied. This limitation explicitly excludes any implied warranty of merchantability or fitness for a particular purpose. The sole remedy for breach of this warranty of material and workmanship or for negligence in manufacture or design is limited to replacement or repair of the fitting, at the sole option of Supplier, of any defective parts which are returned to Supplier (prepaid) within seven (7) years of original purchase. In no event shall Supplier be liable for indirect, special, incidental or consequential damages of any kind. No allowance will be made for repairs made by the purchaser.

SUPPLY LINE WARRANTY

Supplier warrants its QuickFitting push fit supply line connectors to be free of defects in material and workmanship in water service and other approved materials, for a period of five (5) years from the date of purchase of the products. Supplier makes no other warranties, express or implied. This limitation explicitly excludes any implied warranty of merchantability or fitness for a particular purpose. The sole remedy for breach of this warranty of material and workmanship or for negligence in manufacture or design is limited to replacement or repair of the fitting, at the sole option of Supplier, of any defective parts which are returned to Supplier (prepaid) within five (5) years of original purchase. In no event shall Supplier be liable for indirect, special, incidental or consequential damages of any kind. No allowance will be made for repairs made by the purchaser.

THIS WARRANTY IS EXPRESSLY IN LIEU OF ANY AND ALL OTHER WARRANTIES AND REPRESENTATIONS, EXPRESS OR IMPLIED, INCLUDING BUT NOT LIMITED TO, THE WARRANTY OF FITNESS FOR A PARTICULAR PURPOSE AND THE WARRANTY OF MERCHANTABILITY. THERE ARE NO WARRANTIES, WHICH EXTEND BEYOND THE DESCRIPTION ON THE FACE HEREOF. THE EXCLUSIVE REMEDY FOR DEFECTIVE PRODUCTS SHALL BE ONLY AS STATED HEREIN.

Quick Fitting Holding Co. does not warrant the design, assembly or installation of the system using QuickFitting or any other QuickFitting brand, but only the components as stated herein. QuickFitting is not responsible for improper design, assembly or installation, or for any modifications of the QuickFitting products.



WARRANTY SERVICE INFORMATION

THE WARRANTY HEREIN IS VOID UPON:

- a) Failure to follow any of the assembly or installation guidelines;
- b) Alteration, misuse or abuse of, or damage to, any of the Supplier products;
- c) Operation beyond the design range, excessive pressure or stress, or mishandling in any way;
- d) Use other than for the intended purpose or in a manner other than as specified by Supplier;
- e) Improper assembly, installation, service or maintenance;
- f) Use on fluids that are abrasive, aggressive, acidic, imbalanced PH or containing metals or chemicals.

This Limited Warranty, and QuickFitting's responsibility, may be further limited, but may not be expanded, by QuickFitting's terms and conditions of sale, as set forth on the reverse side of the QuickFitting invoice.



QUICKFITTING[®]

**OVERBUILT,
NOT OVERPRICED.**

Quick Fitting Holding Company, LLC.
655 Waterman Ave., East Providence, RI 02914
Tel: (877) 238-4826 • Fax: (877) 258-4826

WWW.QUICKFITTING.COM

05/22