

High Tensile Installation Guide



TABLE OF CONTENTS

- Pre-Installation 2-3
 - Planning the layout 2
 - Utilities location 2
 - Personal safety 2
 - Suggested number of wires ... 3
 - Post placement 3
- Installation 4-14
 - Drill or Drive? 4
 - End anchor and corner posts .. 4
 - Posts (Driven) 4
 - Posts (Hand set) 4
 - Stringing a guide wire 5
 - Tensioning a guide wire 5
 - Installing line posts 6
 - Bracing 6
 - Installing braces 7
 - Brace wires 8
 - Sweep corners 8
 - Installing wire 9
- Stapling techniques 10
- Paying out wire 11
- Insulators 11-12
- Tensioning 12-13
 - In-line strainers 12
 - Tension indicator springs 13
 - Chain grab puller 13
- Electrifying the fence 14-15
 - Gate openings 14
- Grounding 15
- Poly spacers 15
- Final inspection 15

PRE-INSTALLATION

The key to a successful high tensile fence installation is advanced plan- ning, combined with proper tools and quality materials. This installation guide provides an overview of how to build and install a high tensile fence. Before you begin, walk the proposed layout to check for any ob- structions that might cause you to have to modify your layout. Chang- ing your layout is easier in the planning stage than in the middle of the installation.

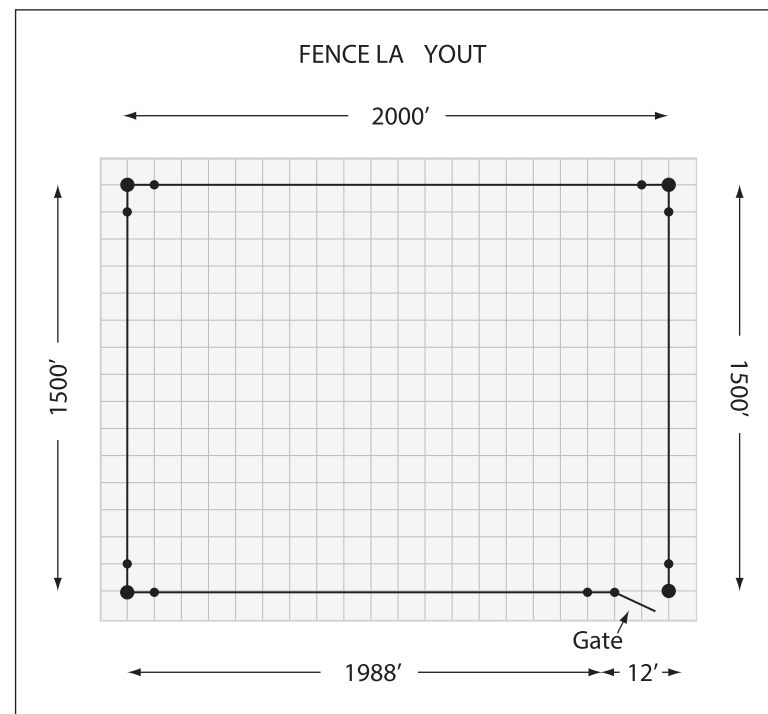

Illustration 2-1

When you are comfortable that your proposed layout will work, draw a measured, or to scale, layout of your fence installation. This drawing will be a valuable planning aid and will also help establish a materials list. To assist you in your planning we recommend that you visit the Fence Planner at www.zarebasystems.com.

Note that the space between posts is determined by the intended use of the enclosure; pasture, corral, feed lot, etc. and by the amount of pressure on the fence or what type of animals and how many animals will be enclosed.

When you have completed your site plan contact your local utility company and schedule an inspection to determine if and where utility lines are located. Typically, a free “One Call” program is available and response is in less than three days. THIS IS VITAL BEFORE DIGGING THE FIRST POST HOLE OR DRIVING THE FIRST POST. Following all safety requirements and guidelines is as important as any component of your plan. This includes, but is not limited to; eye protec- tion, gloves, and steel toed work boots. Also, use ear protection when operating power augers or post drivers.

Recommended Number of Wires and Spacing

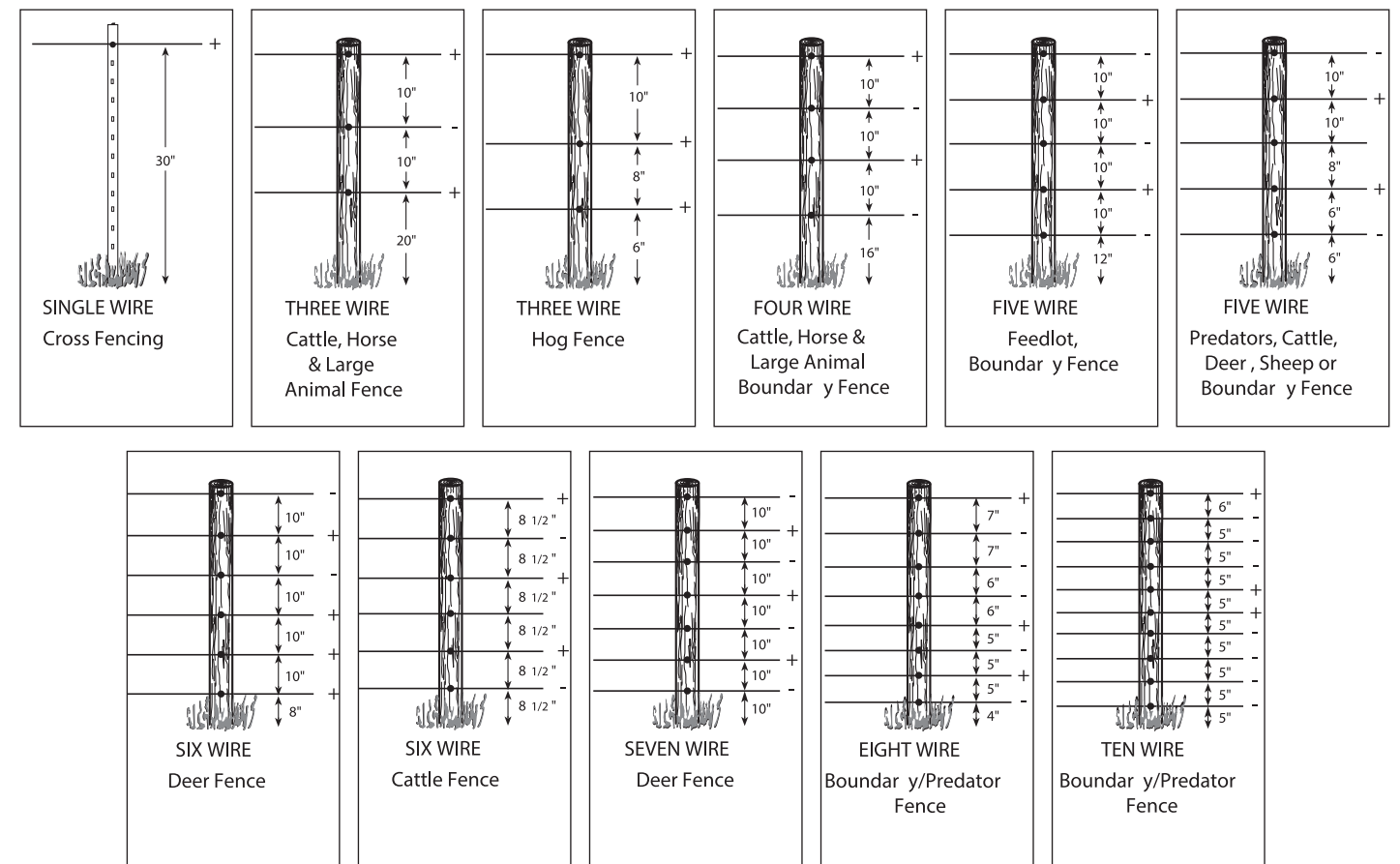

Illustration 3-1

Recommended Wood Post and Poly-Spacer Spacing for Flat Terrain

Application (stable soil)	Post Spacing	Poly-Spacer Spacing	No. of Wires
PASTURE Light Pressure	48'	12'	4 – 6
PASTURE Medium Pressure	40' 36'	10' 12'	4 – 6
PASTURE Heavy Pressure	30' 24'	10' 8'	6 – 10
CORRAL/LOT Light Pressure	20'	10'	4 – 6
CORRAL/LOT Medium Pressure	16' 12'	8' 6'	4 – 6
CORRAL/LOT Heavy Pressure	8' 6'	4' 3'	6 – 10

Table 3-1

INSTALLATION

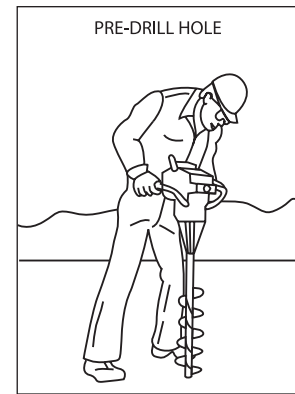

Illustration 4-1

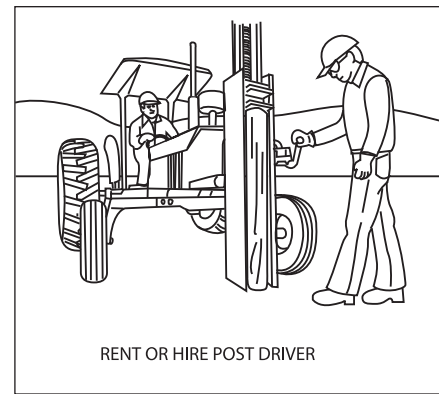

Illustration 4-2

Begin by installing all corner and end posts, followed by dip and rise posts. These posts will support the guide wire used to position the remaining line posts. Posts can either be hand-set or driven into the ground using a hydraulic post driver. Installation will vary slightly depending on which method you choose. Follow installation of end anchor, corner, rise, and dip posts by stringing a guide wire.

END ANCHOR AND CORNER POSTS

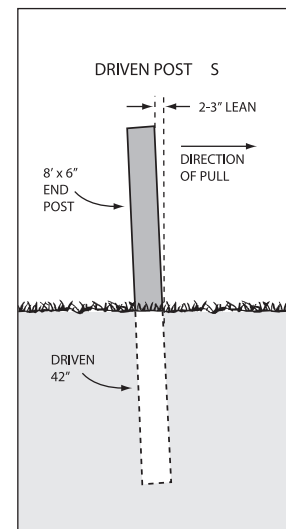

Illustration 4-3

All end anchor and corner posts must be at least 96" long and are nominally 6" in diameter. They should be buried at least 42" into the ground and set with a 2"-3" preloaded lean (away from the pull of the fence: see illustration). Set these posts at all corners, ends, and where there are major dips and rises in the terrain. Posts set where gate openings are located should be set plumb so that gates will swing properly.

DRIVEN POSTS

Driving posts into the ground using a hydraulic post driver is by far the most efficient method of installing posts. Not only do driven posts have 10 times the pull out resistance of hand-set posts, there is a significant savings in the labor required to set posts using this method. Before deciding which method to use, check with your local rental supply store for the availability of a driver or a referral to where one can be obtained. Often, driving posts into the ground using a hydraulic driver can be sub-contracted if you choose.

Driven posts are always set with the small end down for the least amount of soil disruption and for greater holding power. Pre-drilling a pilot hole will facilitate driving posts into hard, rocky soil.

HAND-SET POSTS

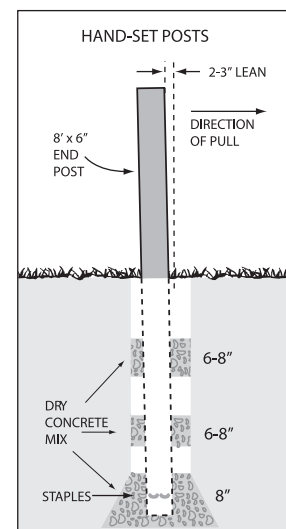

Illustration 4-4

While power driving posts is the choice of most people, hand-setting posts is, of course, a very viable way to accomplish a favorable result. This method requires some additional steps to assist in preventing pull out.

Using a power auger, drill a 12" hole at least 42" deep with a bell shape at the bottom of the hole.

When hand-setting posts always place the larger end of the post into the ground for greater stability and holding power. Hammer a ring of staples into the larger end of the post about 4" from the bottom, leaving one half of the staple exposed for a better grip.

Place the post in the hole and fill the bottom 8" with dry concrete. Firmly tamp the concrete mix and then add and tamp 6" of soil. Tamp and alternate concrete and soil until the hole is filled (see illustration). Over time the concrete will absorb the required amount of moisture and harden to securely anchor the posts. You can, however, add water to accelerate the process.

Don't forget to lean the post 2" to 3" away from the direction of the fence pull as you are back-filling the hole.

STRINGING A GUIDE WIRE

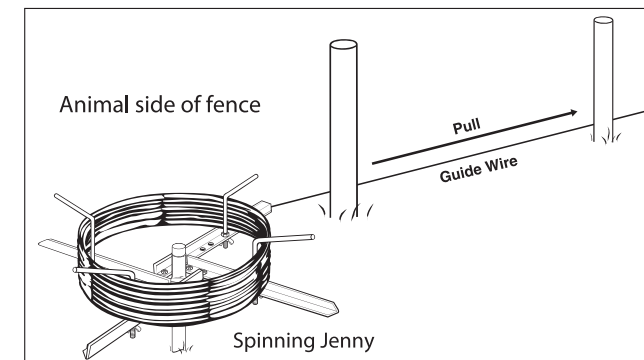

Illustration 5-1

We recommend using 12 1/2 gauge, 200,000 psi Class 3 galvanized wire for your fence. It normally comes in 4000 ft. coils, weighing just over 100 lbs. The most practical way to install fence wire is to use a "spinning jenny" wire de-reeler or other similar device.

Place the wire on the spinning jenny and carry the lead end to the first end post. Gate posts are end posts in a run. Position the wire on the outside of corner posts. Wire placement on line posts is on the pressure (animal) side of the posts, and depends on whether you wish to contain or to exclude animals.

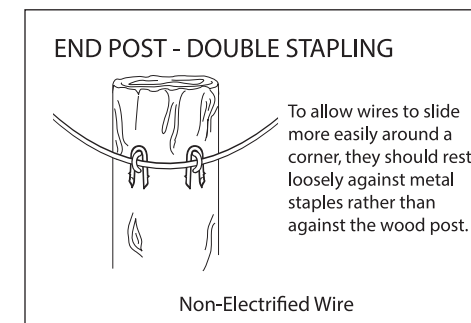

Illustration 5-2

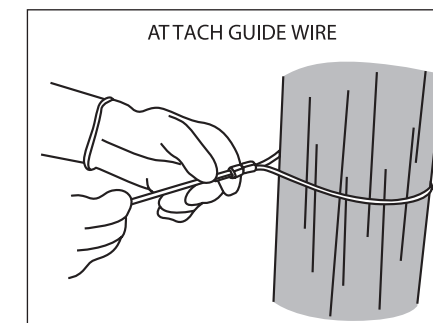

Illustration 5-3

With the wire paid out to the end of the fence or at a gate, attach it to the post by looping it around the post and splicing the free end to the guide wire using two crimp sleeves. Position the wire at the desired height and secure it there by driving (2) line staples into the end post. Generally the height of the guide wire is 4" to 8" above the ground depending on your wire spacing.

Staples are not driven "home" when securing the guide wire. There must be sufficient space left for the wire to be able to move for tensioning and to allow for expansion and contraction.

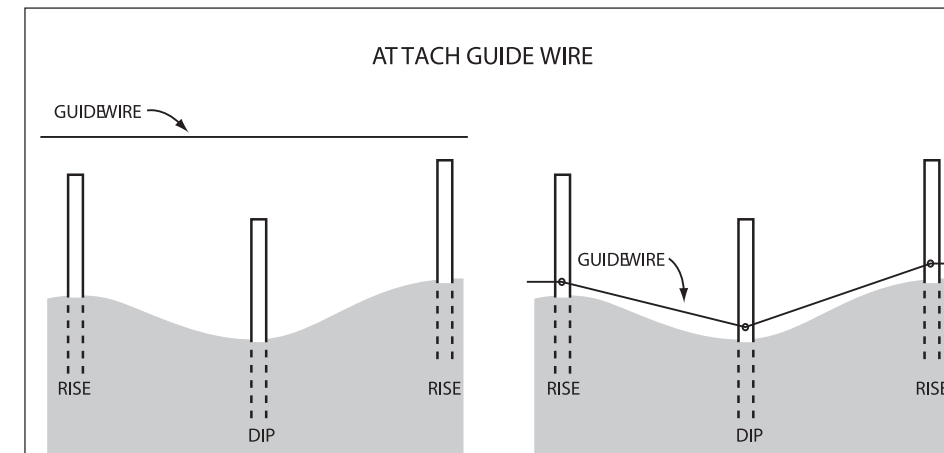

Illustration 5-4

Work your way back to the beginning, securing the guide wire to the dip and rise posts at the desired height. Dip and rise staples are driven in slightly differently than other posts. Read Stapling Techniques, page 10.

Guide wire is placed below the staple on a dip post and above the staple on a rise post. Wire is secured in place with a second staple.

When the guide wire is attached to all posts, apply tension.

TENSIONING

Apply tension to the guide wire after it is attached to all posts.

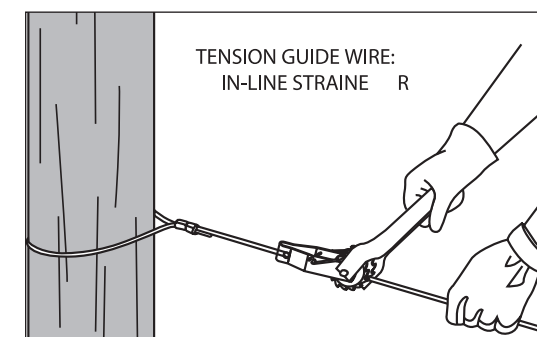

Illustration 5-5

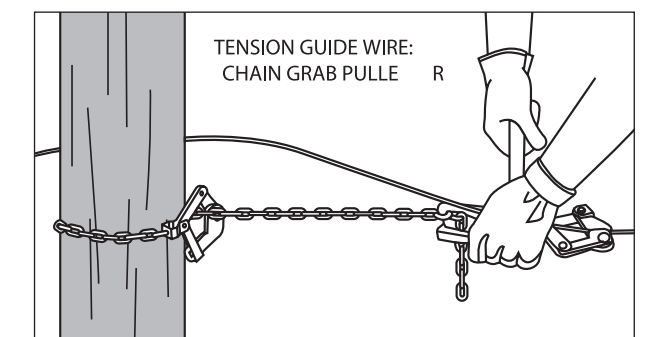

Illustration 5-6

INSTALLING LINE POSTS

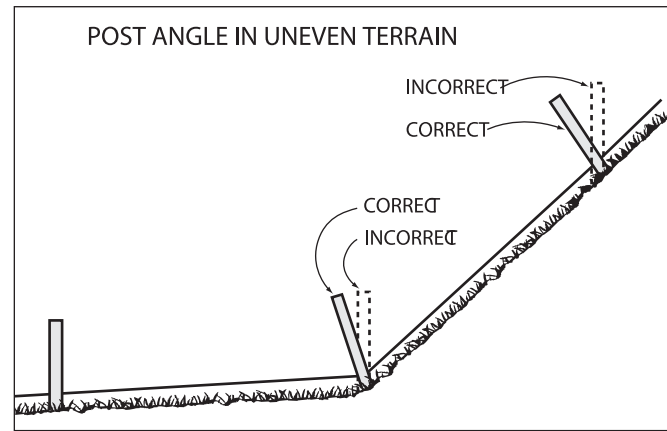

Illustration 6-1

With the guide wire installation completed your enclosure is now well defined, including openings. Using the table on page 3, determine the distance between line posts in your installation. Measure and mark the location of each line post using either a flag or spray paint.

Line-posts should be at least 84" long and a nominal diameter of 4". Line posts are installed the same as end and corner posts, but do not need to be driven in or hand-set with a pre-loaded lean. Hand-set line posts require pre-drilling a hole the size of the post and do not require concrete.

Line posts are always set perpendicular to the ground. (See illustration). In many cases they will not be plumb. Complete setting all posts. The guide wire can now be secured to all of the posts- again with the staples not driven home.

BRACING

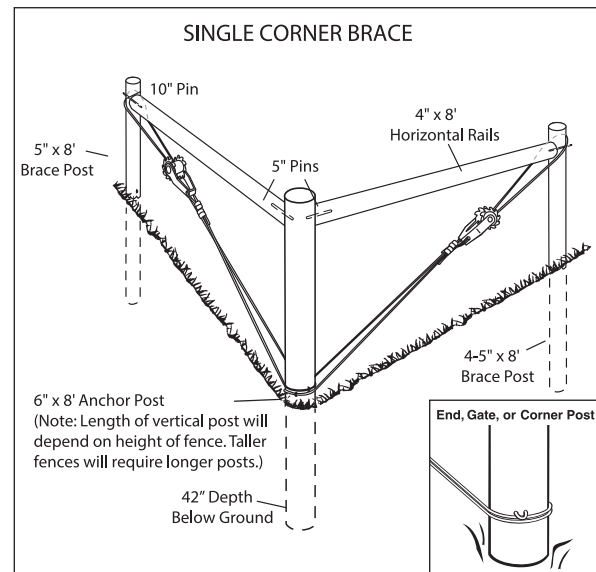

Illustration 6-2

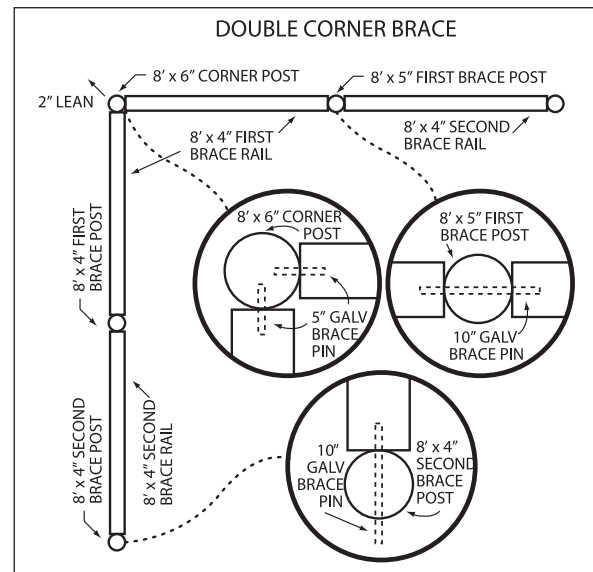

Illustration 6-3

The accepted rule with bracing is that corners that are more or less 90° and have less than 6 wires require only a single brace. Corners with more than 6 wires require a double brace. End posts are braced as a half corner. Sweep corners are treated differently than other corners.

INSTALLING BRACES

Measuring from the inside of the corner or end post, mark where you will set the brace post: an amount equal to the length of the brace rail to the inside of the brace post. Either hand-set or drive the first brace post. With the first brace post set, measure and set the second brace post if one is required. A single brace post must be tilted back 2"-3" as with corner or end posts. In the case of a double brace, the second brace post is set perpendicular to the ground.

Horizontal rails are positioned between the top and second fence wire.

BRACE PINS

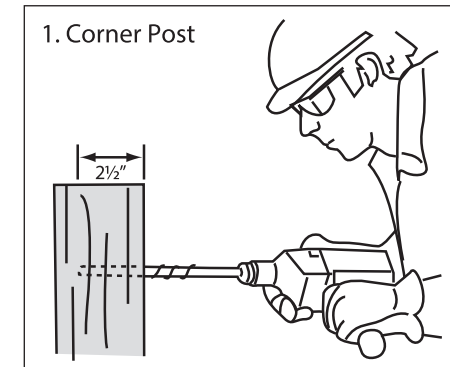

Illustration 7-1

With all posts in place, drill holes for brace pins using a 3/8" x 10" long wood bit. Corner post pin holes are 2 1/2" deep.

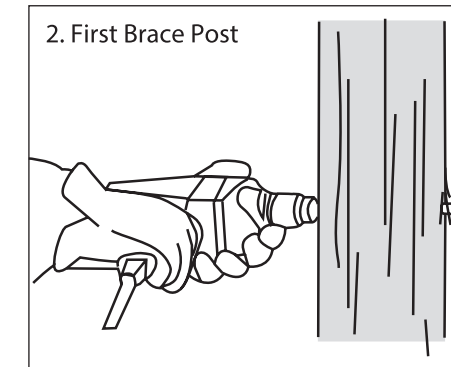

Illustration 7-2

Holes for the brace posts are drilled through the post at the same height as the corner post brace pins, and in line with the layout of the fence.

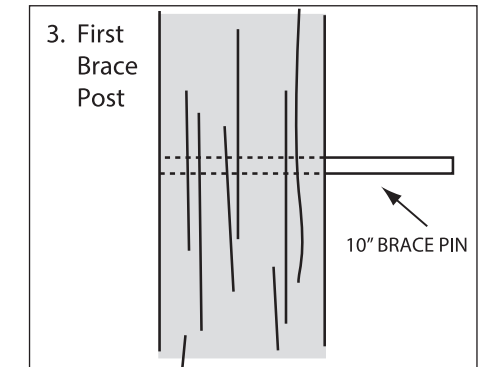

Illustration 7-3

Drive a 10" pin into the hole in the far end post just until it is visible on the inside of the post.

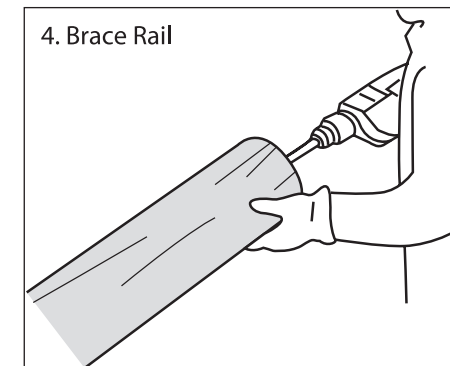

Illustration 7-4

Drill a 3/8" hole into the center of the corner end of the brace rail approximately 2 1/2", and a hole into the center of the far end of the rail approximately 4" deep.

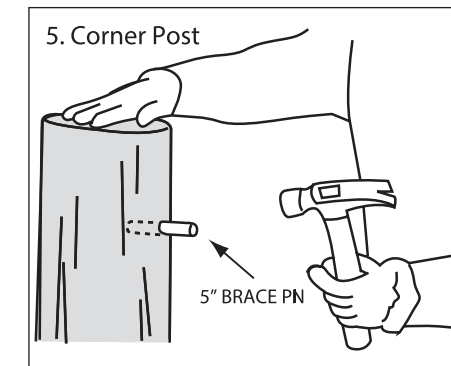

Illustration 7-5

Drive a 5" pin into the corner post. Slide the rail (corner end) onto the corner post rail pin and finish with the rail being between the two posts.

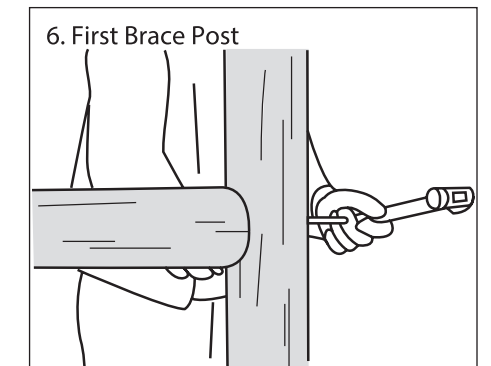

Illustration 7-6

Drive the pin into the hole in the brace end of the rail, leaving about 2 1/2" of the pin exposed.

If installing a double brace, finish installing the brace wire onto the first brace before constructing the second brace. When tension has been applied to the first brace wire, proceed to repeat the process until the second brace is constructed and tension applied to its wire.

BRACE WIRE

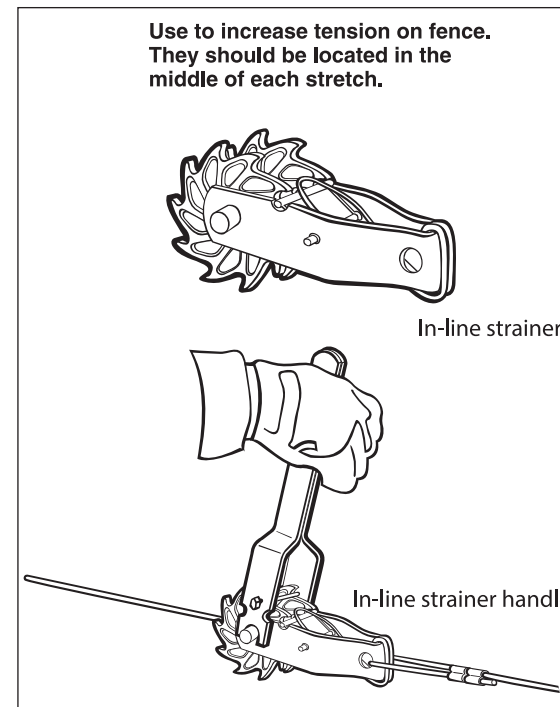

Illustration 8-1

Caution: Over tightening brace wire can result in it breaking and a recoil might result, placing anyone near the corner in extreme danger. Be very careful not to over tighten the brace wire.

Weave a length of wire around the corner post and brace post in a double figure 8, making two complete circuits. Position this wire below a keeper staple driven into the corner or end post at a height of 4" to 6" from the ground and above the exposed rail pin in the brace post. (See illustration 6-2, page 6).

While there may be a number of ways to establish and maintain the required tension on this wire, we are illustrating using an in-line strainer.

To use an in-line strainer, connect it to the upper wire of the two free ends of the brace wire, insert the lower free wire into the strainer and ratchet the strainer until there is no space in the joints where the horizontal rails and posts meet. Ensure that all strands of the wire have relatively equal pull exerted on them. Unequal tension is caused by the wires binding in the wrap and can be corrected by loosening the strainer and making a correction to the way the wires overlap each other. Cut excess wire near the crimping sleeves for maximum safety.

SWEEP CORNERS

It is not always practical to use a brace when making a change in direction in the installation of a high tensile fence. There are several ways to facilitate bracing against additional pull, including the non-typical installation of a single post corner or a sweep corner.

An alternative to the post and rail brace is installing sweep corners using posts set at more extreme angles than instructed previously. By following the examples shown in this section, almost any degree corner can be built with confidence that it will stay securely in place for many years. Typically, sweep corner posts are set with a 4" lean away from the pull of the wire. See the illustrations below for examples of different sweep corners. Generally posts used for sweep corners are 96" long x 4" in diameter and set 48" in the ground.

The wire, of course, should be strung to the outside of the post.

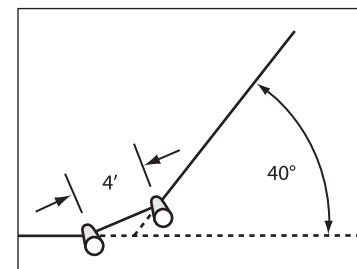

Illustration 8-2 CORNER - DOUBLE POST

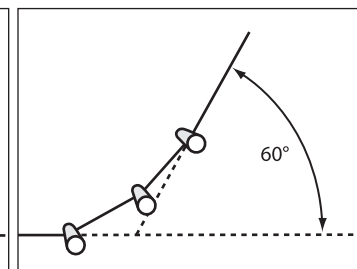

Illustration 8-3 CORNER - THREE POST

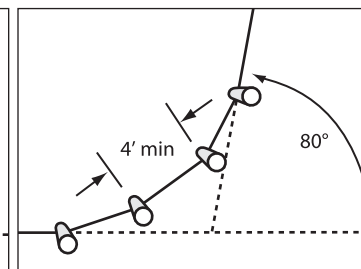

Illustration 8-4 CORNER - FOUR POST Commonly used at the intersection of two roads.

INSTALLING THE WIRE

Begin by marking each post to establish the wire location using a tape measure or pre-marked measuring stick and using the guide wire to measure from. Use a carpenter's crayon or marker.

Note: Should you choose to install high tensile Class 3 wire through drilled treated posts, regardless of the precautions taken, free standing moisture will likely settle and impair the expected life of the wire. U.S. Steel, in their original installation book, referred to this method of wire placement as being acceptable; however, if you expect long life from your Class 3 wire, Woodstream Corporation, the parent company of the brand of wire that you are installing, does not recommend placing wire through drilled treated posts.

INSTALLATION TIPS

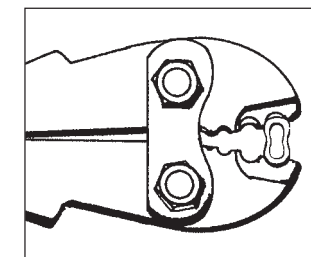

Illustration 9-1

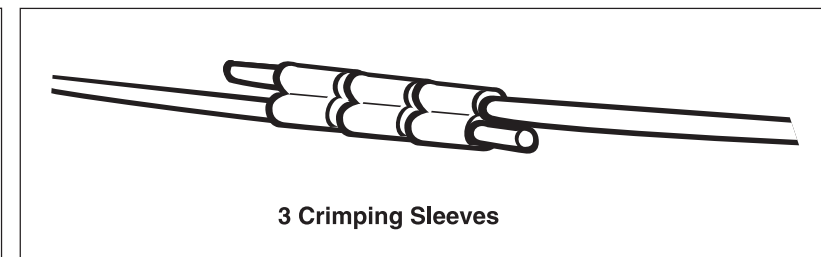

Illustration 9-2

- When using multiple crimping sleeves, place them against each other for maximum holding power.
- To avoid tangling, string one strand of wire around the enclosure and attach it to the post before paying out the next wire.
- Measure the placement of all wire from the guide wire which was already attached to the post.
- A non-electrified wire can be wrapped around a post and secured to itself using two (2) crimping sleeves.
- An electrified wire requires a wrap-around insulator and can be secured to itself, as with non-electrified wire.
- High tensile Class 3 wire can be spliced effectively using three (3) crimping sleeves.
- Remember to slide extra crimping sleeves onto the wire to be electrified at gate openings on both sides and at the location where the controller will be connected to the fence.
- Remember to slide insulated plastic tubing onto the wires to be electrified at post braces where the brace wire crosses the fence wires. This includes both corners and end anchor posts at gate openings as well (see illustration #14-2, page 14).
- Use crimping sleeves with grit inside to better "bite" the wire for improved holding strength.

STAPLING TECHNIQUES

Note: Staples are not driven home when securing high tensile fence wire. The wire must be able to move within the staple for tensioning and for normal expansion and contraction. Any exceptions to this rule will be noted.

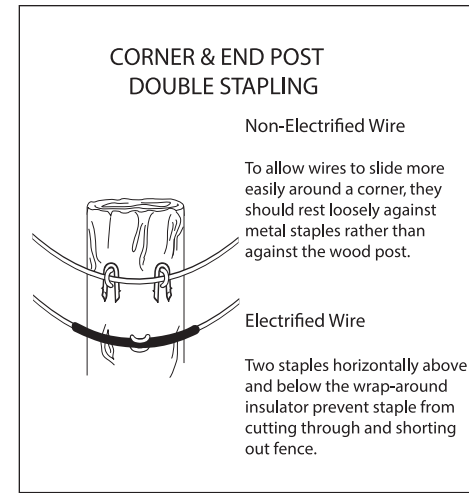

Illustration 10-1

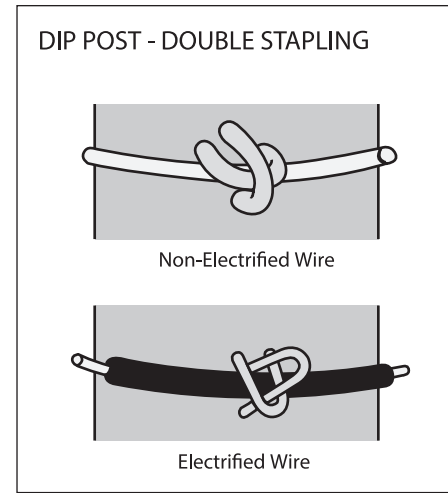

Illustration 10-2

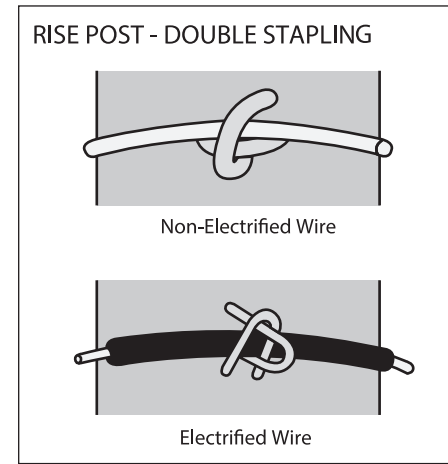

Illustration 10-3

- Drive line staples in leaving a 1/4" gap so the wire can move freely beneath it.
- Line staples securing "fin" tube insulators need only compress the fins, not crush the insulator.
- Keeper staples are driven in so more of the staple is exposed to hold the wire in place.
- Attach non-electrified wires directly to the line posts with staples (insulators are not required).
- Dip and rise posts require a special double stapling technique so the wire doesn't pull the staple out of the post (see illustration #5-4, page 5). Dip post staples are driven in at an "up" angle because the wire is pulling up: rise post staples are driven in at a "down" angle because the wire is pulling down. Both rise and dip posts require a locking staple to keep the wire in place.
- Be sure to use 8 or 9 gauge Class 3 galvanized, barbed type staples for longest product life. Use a slash cut staple that is at least 2" long and drive it in at a 30° to 40° angle from vertical (see below). This will cause the legs of the staple to spread outward, providing a better hold.

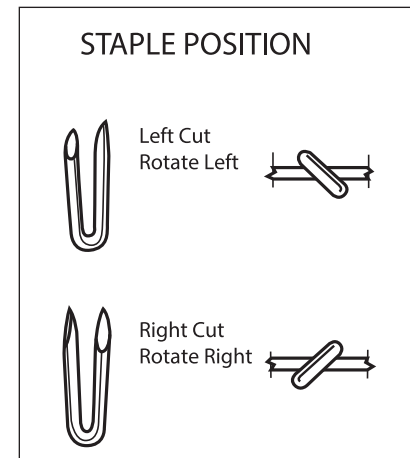

Illustration 10-4
The tilt of the staple is determined according to how the slash cut is made. If the slash cut is on the top left side of the staple with the legs of the staple pointing away, it tilts to the left when driven in. If the slash cut is on the top right side of the staple with the legs of the staple pointing away, it is driven in tilted to the right.

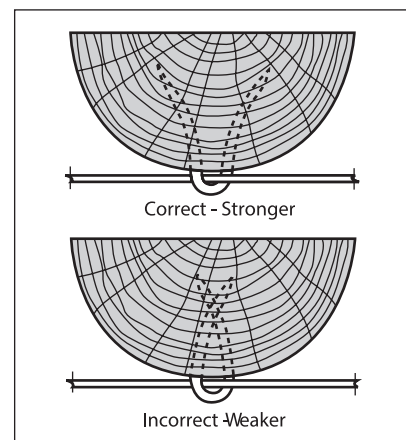

Illustration 10-5

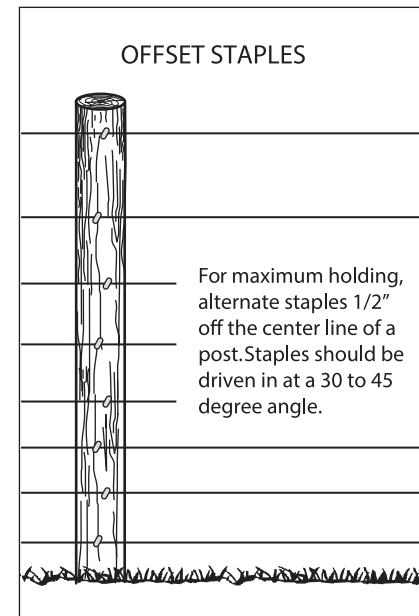

Illustration 10-6
Stagger the alignment of the staples in a post so they are not all on the same grain when driven in, which may cause the post to split.

PAYING OUT THE WIRE

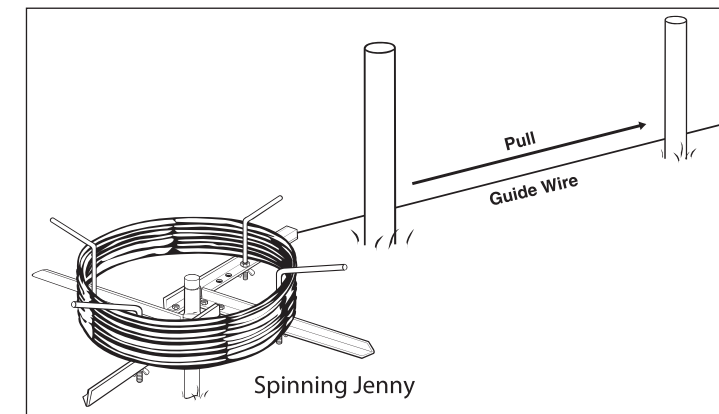

Illustration 11-1

High-carbon wire (high-tensile) is very strong and quite active. In order to effectively control the wire while working the fence line, a spinning jenny (de-reeler) or similar device, must be used. Count the number of posts in the run and make sure to put that number of insulators onto the wire as it is drawn out. Don't forget to include wrap around insulators on the electrified wire for around the corner posts. Unlike other types of fencing, you do not have to tie off at every corner. Merely string the wire around the back side of the corner brace and then return the wire to the inside of the next line post and continue on. When pulling wires that will be electrified around a post, drive keeper staples horizontally, above and below the wrap-around insulator, positioned at the desired height. Never staple directly into the wrap-around insulator.

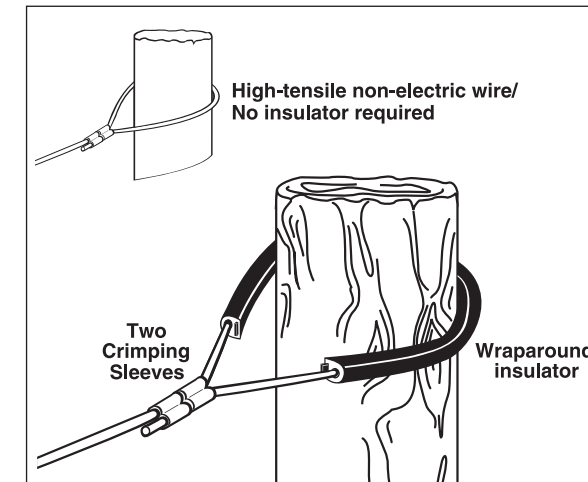

Illustration 11-2

When pulling a non-electrified wire around a corner, place a staple behind the wire, over the top of each line staple to eliminate drag when pulling or tensioning the wire (see page 12). Stop paying out wire every 165 feet (10 rods) and install the wire onto the posts. Wires should be installed from the bottom to the top with each course completed before starting the next.

Wires should be left somewhat slack so that in-line strainers and a tension spring can be added. Installation of the in-line strainer and tension spring requires an additional 12" to 18" of wire.

With all wire paid out and strung on the posts, pull the wire around the starting post and splice the free end to the run using two (2) crimping sleeves. Wires that will be electrified require wrap around insulators.

INSULATORS

There are a number of options to consider when choosing the type of in-line post insulator to be used in your fencing plan.

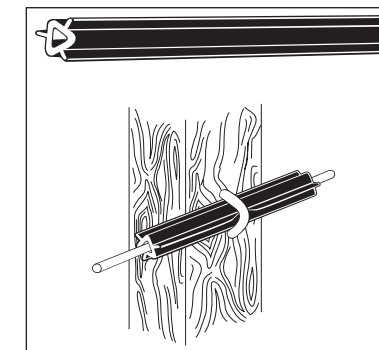

Illustration 11-3

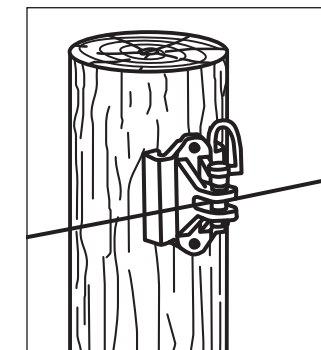
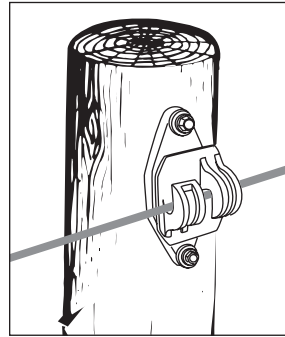
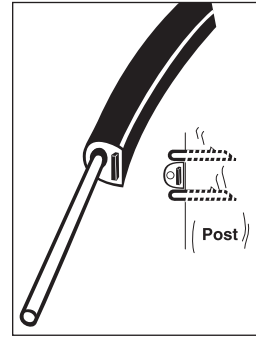

Illustration 11-4

The second option is a heavy duty pin lock insulator, which can be installed after the fence is constructed. This method is particularly desirable when it is not practical to use a fin tube insulator. It is installed using galvanized screws and a battery operated power drill, or it can be nailed to the post. Wires can be detached from the post with this type of connector without having to remove the screws or nails securing it to the post.



The third option is a heavy duty claw insulator, which also permits the wire to move freely. It also can be installed after the fence is constructed, using galvanized screws and a battery operated power drill or it can be nailed to the posts.



A wrap-around insulator used for corner and end posts is fabricated of long life polymers with a high strength insert to prevent the tube from being cut when tension is being applied to the wire.

Illustration 12-1

Illustration 12-2

TENSIONING

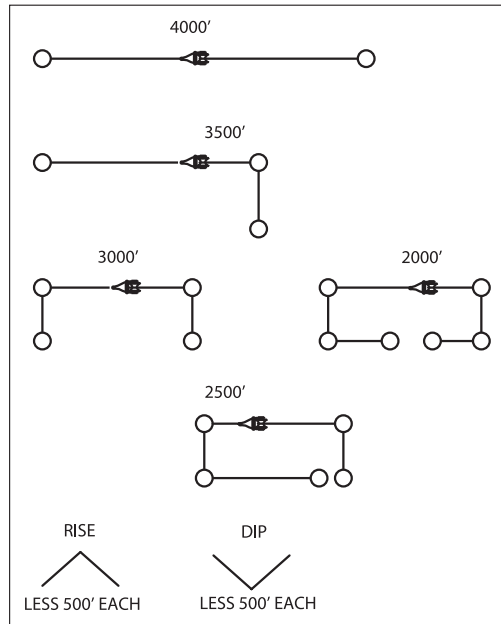

Illustration 12-3

IN-LINE STRAINERS

In-line strainers are capable of pulling 4000 feet of wire, however, for each friction point such as a corner, sweep, dip, or rise, deduct 500 feet of pull capability.

In-line strainers are best installed in the middle of the run in order to better equalize the stress on the wire. When installing the in-line strainer, wrap 12" to 18" of wire onto the strainer for future use in the event of a break in the wire.

With all fencing wire installed, choose locations to add in-line strainers. Used to add tension to the fence wire, in-line strainers are typically put into the fence somewhere in the middle of the run in order to equalize the pull on the wires. Generally, one in-line strainer is effective for every 4000 feet of fence. Every friction point (corners, rise, and dip posts) reduces the wire handling capability by 500 feet. A 4000 foot fence with three corners requires 2 strainers. Any other change in direction where the fence wire is strung behind a post reduces the capability of the strainer by 500 feet.

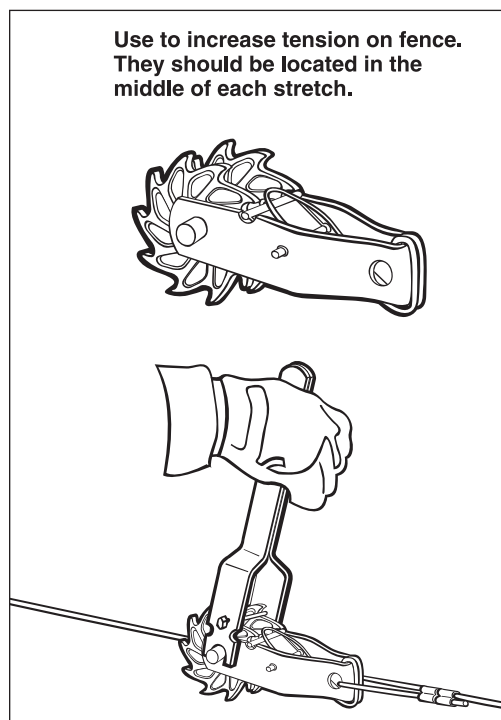

Illustration 12-4

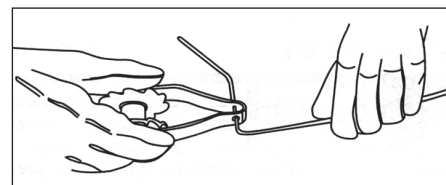

Illustration 12-5

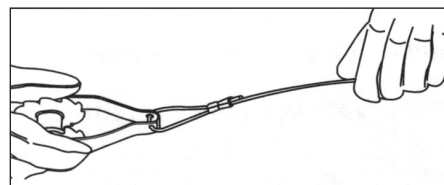

Illustration 12-6

TENSION INDICATOR SPRINGS

Tension indicator springs are installed, usually, in the second wire from the top to accurately measure fence tension. These springs feature full length tug links with marks to indicate the tension applied to the wire. The first notch is 125 lbs., the second is 250 lbs. Only one tension indicator spring is required per section of fence with tension. Other wires at that location are hand gauged by plucking the wires, like a guitar string, to check their tension compared to the wire with the indicator spring.

To install tension indicator springs, follow the steps shown in illustrations below.

Using an in-line strainer handle, begin to tighten the wires. If anchor posts have been hand-set using concrete, two or three days must pass before fully tensioning the wire. Tighten the wire with the tension spring until it is compressed to the second notch which is 250 lbs. Hand gauge the other wires at this location.

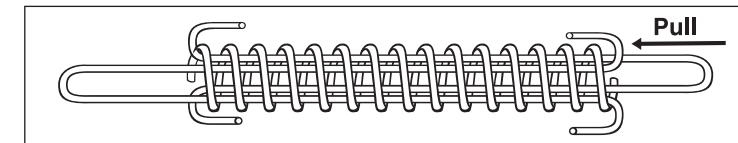

Illustration 13-1 Disassemble by pulling link at arrow.

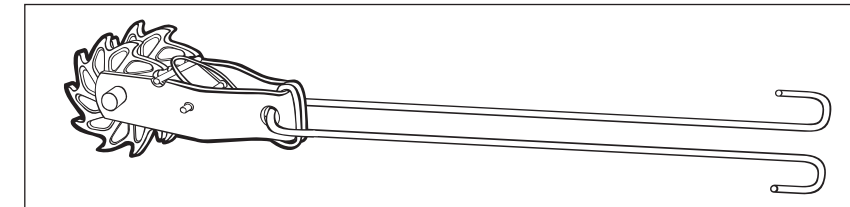

Illustration 13-2 Thread spring link into strainer.

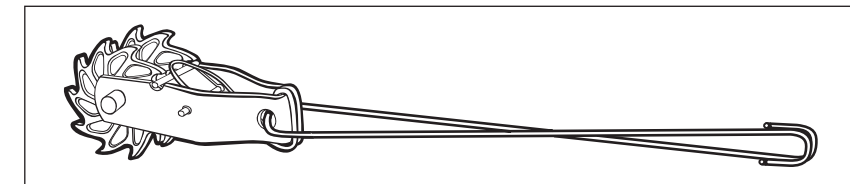

Illustration 13-3 Squeeze ends of spring link together and push into spring assembly.

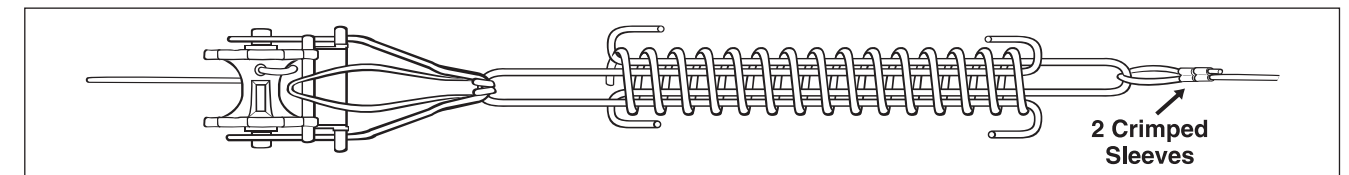

Illustration 13-4 Thread free end of fence into strainer spool and ratchet to tighten.

CHAIN GRAB PULLER

If a chain grab puller is being used to add tension to the fence, a tension indicator spring can be installed to provide guidance as to how much tension is being applied before securing the wire to the post. Install the tension indicator spring in the second wire from the top and add tension using the chain grab puller until the desired tension is attained. Other wires at that location are hand gauged by plucking the wires like a guitar string to check their tension compared to the wire with the indicator spring.

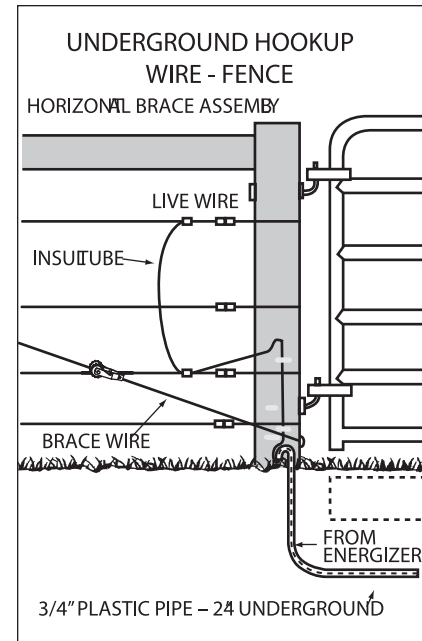

Illustration 14-1

ELECTRIFYING THE FENCE

With all wires installed and tensioned, connect wires to be electrified to each other using high tensile wire with insulated plastic tubing or insulated jumper cable. Connect these wires to the fence using crimping sleeves.

If you failed to include extra crimping sleeves on the fence at this location when securing the wires to be electrified to the posts, use an "electric tap" which is designed for connecting new wires to installed wires.

Repeat until all wires that are to be electrified are connected to each other. Next, install and connect your electric fence energizer to the fence using crimping sleeves or electric taps. Install the unit indoors if it is an AC powered unit, or outside in an enclosure if it is a battery operated unit.

Use 20,000 volt hook up wire to make the connection between the fence terminal on the energizer and the fence wire to be electrified, and from the ground terminal on the energizer to the grounding rod. Secure this connection with a brass ground rod clamp. The first grounding rod must be driven into the ground within 20' of the energizer. See illustration, next page.

GATE OPENINGS

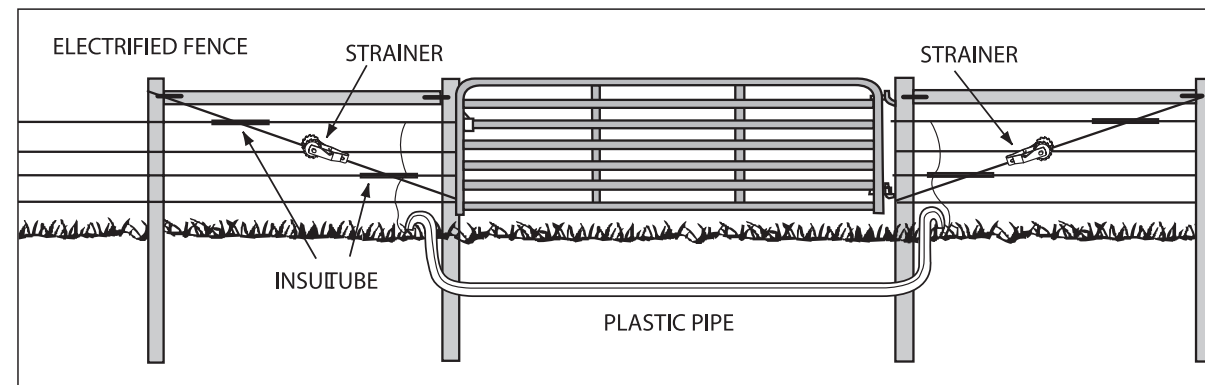

Illustration 14-2

To create a non-electrified gate opening in your fence, bury an electrified wire under the gate opening to jump the electrical connection across the opening. First, dig a trench across the opening at least 24" deep. Then place a heavy wall 3/4" water pipe in the trench so that there is an excess of 12" of pipe extending up, out of both sides of the ditch. Next, thread a piece of 20,000 volt insulated hook up wire through the plastic pipe until it comes out the other end.

Leave at least 18" of wire at both ends of the pipe. Back fill the trench and tamp the loose soil. Bend at least 6" of the pipe down on both ends to prevent water from getting in the pipe. Wire can be wrapped around the bend to maintain its shape.

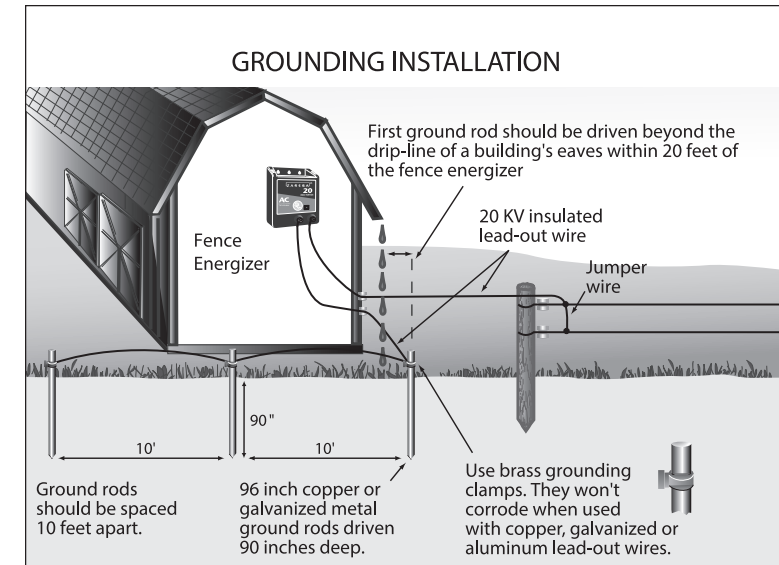

Illustration 15-1

Effective grounding is perhaps the most important component in establishing a successful electronic animal containment system. More problems are caused by poor grounding than any other issue. For maximum fence performance, drive three (3) 1/2" x 96" galvanized or copper ground rods into the earth either perpendicular or in the opposite direction of the fence, 10 feet apart, leaving 6" +/- of the rod exposed. Connect these three rods together using 20,000 volt hook up wire and brass ground rod clamps.

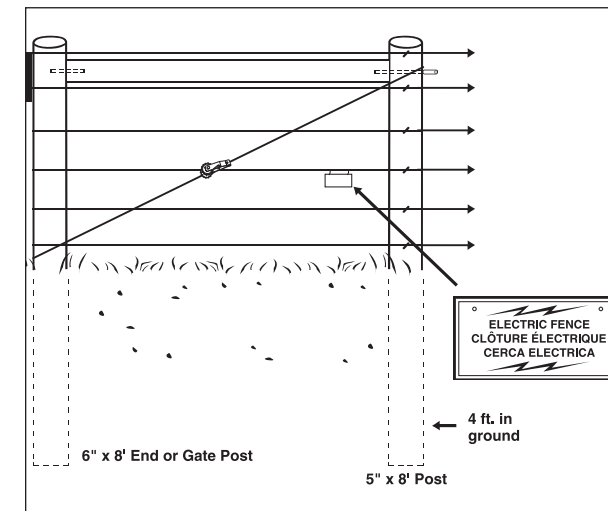

Illustration 15-2

Using 20,000 volt insulated hook up wire as a jumper, connect the wires of the fence which are to be electrified, on both sides of the gate. Connect the gate jumper wire to the lowest electrified wire on each side of the gate.

All of the jumper wires should be installed using crimping sleeves provided for this purpose during the fencing wire installation, or by using fence taps.

Before energizing the fence, walk its perimeter and visually check the installation for forgotten insulators, staples driven through an insulator, touching a wire, or poor connections at jumper wires. Remove any debris such as limbs or tall grass that might be touching the fence and causing an unwanted grounding effect. Also, this is a good time to hang warning signs and/or flags every 300' or so, as required by law in many areas of the country (check your local ordinance). Even if these signs are not required, they are a good idea to include around the fence perimeter.

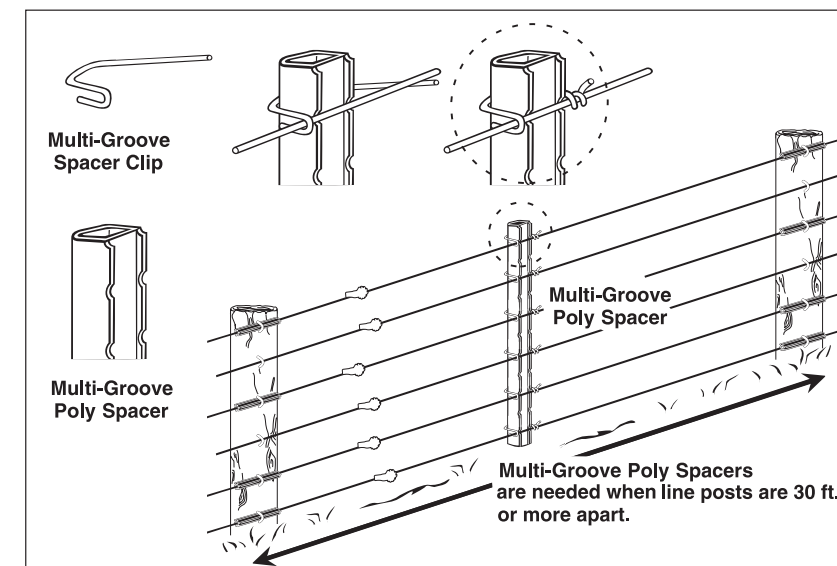

Illustration 15-3

INSTALL POLY SPACERS (IF NEEDED)

Use poly spacers to ensure wire spacing in integrity when line posts are spaced more than 30' apart. Attach pre-formed spacer clips to each wire loosely, with a twisting tool, so as to allow lateral wire movement.

ENERGIZE

With the quality of the fence installation verified, the energizer can now be activated. Using a voltage tester or other similar device, check to ensure that there is current flow and that the voltage is correct.

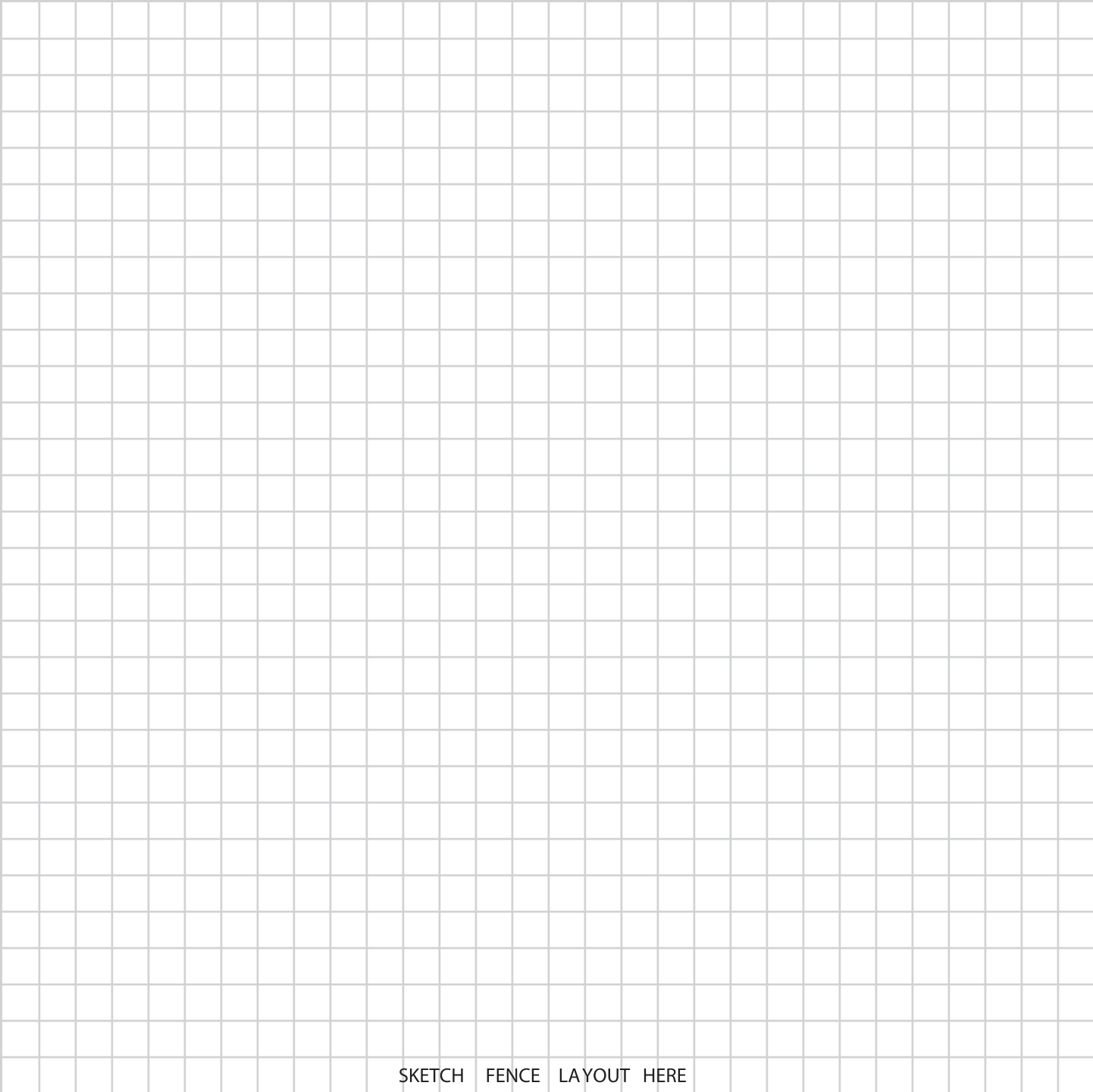

SKETCH FENCE LAYOUT HERE

Woodstream Corp.

Lititz, PA 17543

855-592-7322

©2013

HTMANUAL

Although the information and recommendations in this High Tensile Installation Guide is presented in good faith and believed to be correct, Zareba Systems makes no representations or warranties as to the completeness or accuracy of the information.

Information is supplied upon the condition that the persons receiving same will make their own determination as to its suitability for their purposes prior to use. In no event will Zareba Systems be responsible for damages of any nature whatsoever resulting from the use of or reliance upon this information.