

# 4 DC CORNER SPACE SAVER

MODEL 99100 MAPLE

MODEL 99300 CHOCOLATE

MODEL 99600 CHERRY

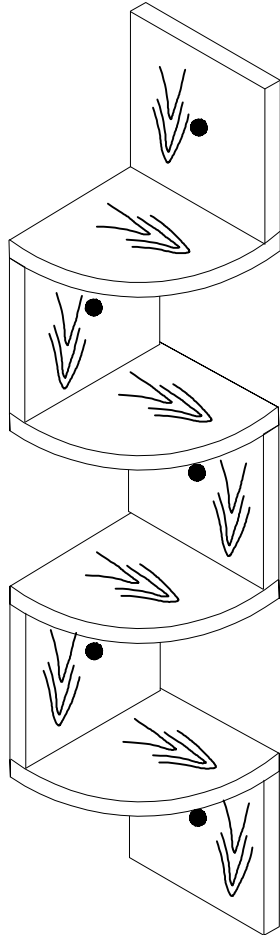

## NEED ASSISTANCE ?

Call 4D CONCEPTS directly for parts or assembly assistance.

Individual stores do not stock parts

Call our Toll-free number 5 days a week except holidays:

Monday through Friday 8.00am to 5.00pm

Pacific Standard Time

**1-888-310-4DCO or 1-888-310 4326**

**IMPORTANT:** Before calling please have the model number and the packing code number ready for our customer service representatives.

You will find the model number printed on the carton label and the packing code printed in black ink on the side of the carton.

Model 99100 Packing code

Model 99300 Packing code

Model 99600 Packing code

It is important that you retain the model number and the packing code along with the original receipt of purchase for future reference.

Made in China

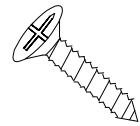
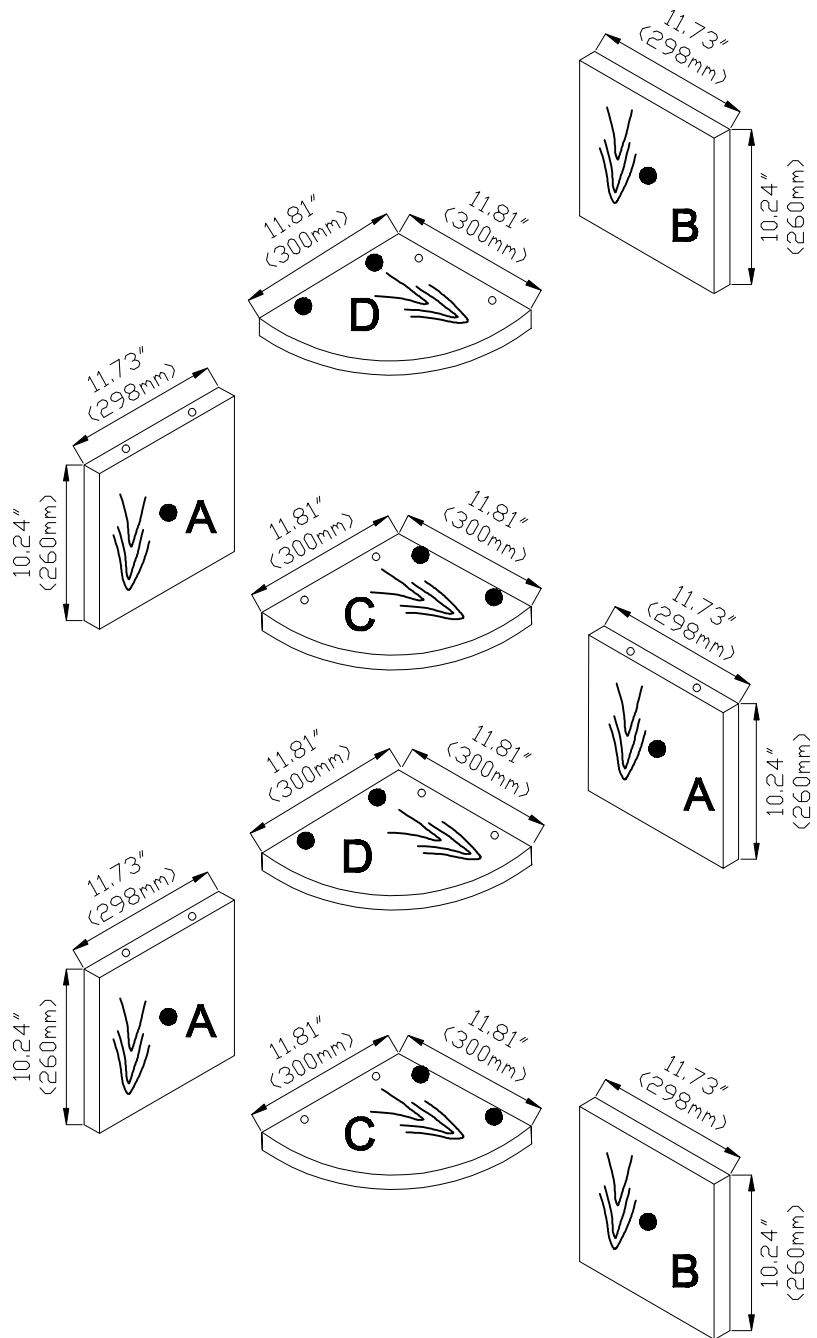

8# X 38 mm  
L X 16

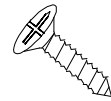

4 X 32 mm  
S X 5

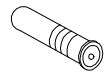

6 X 26 mm  
T X 5

- Indicating countersunk hole
- Indicating regular screw hole

Please follow woodgrain direction as below diagram when assembly

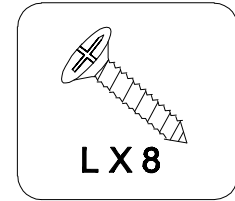

1.

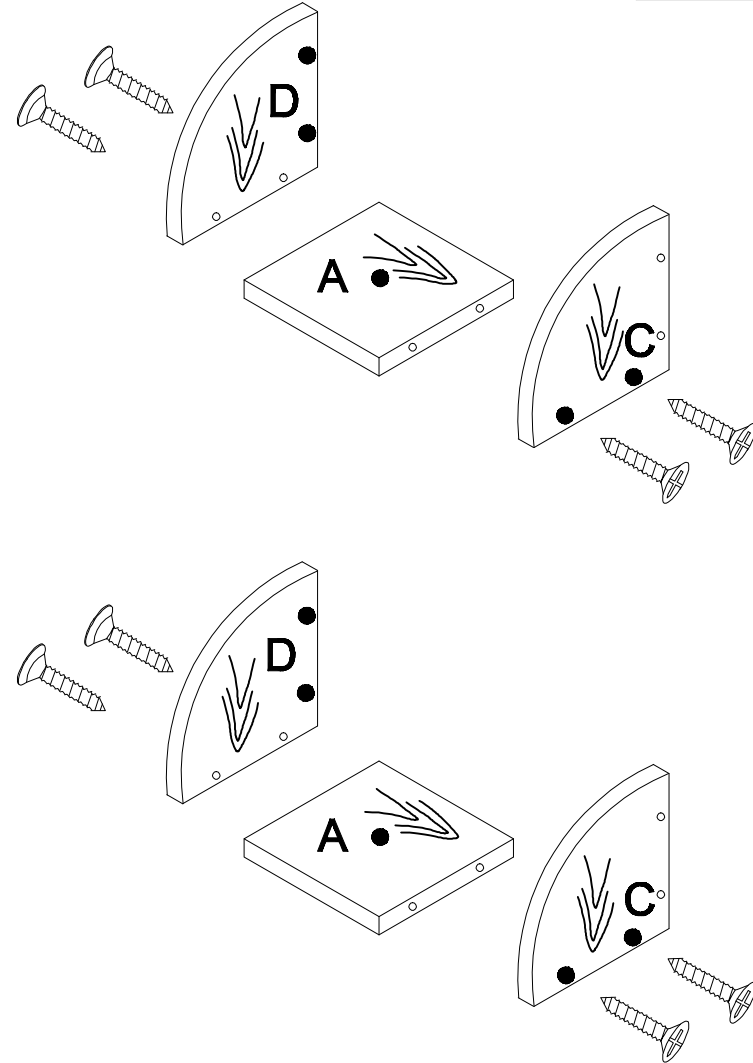

2.

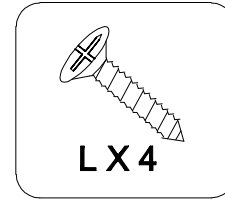
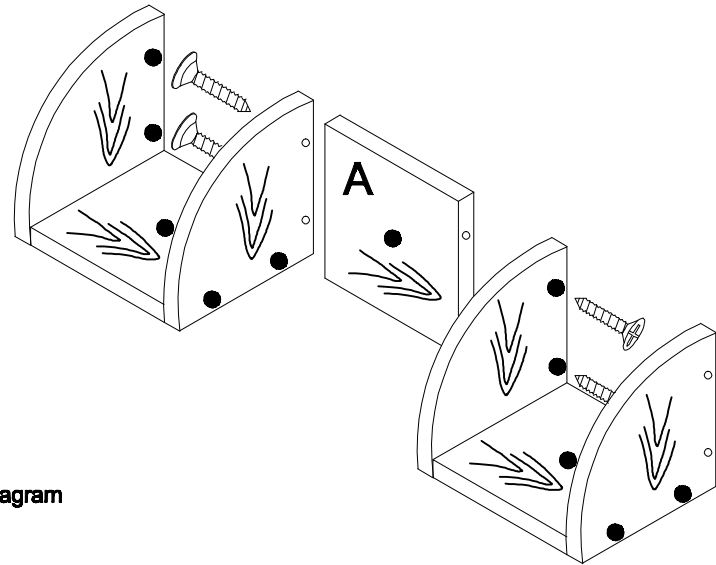

- Indicating countersunk hole
- Indicating regular screw hole

 Please follow woodgrain direction as below diagram when assembly

3.

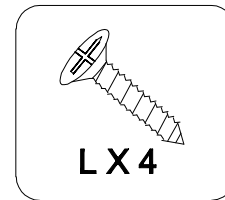
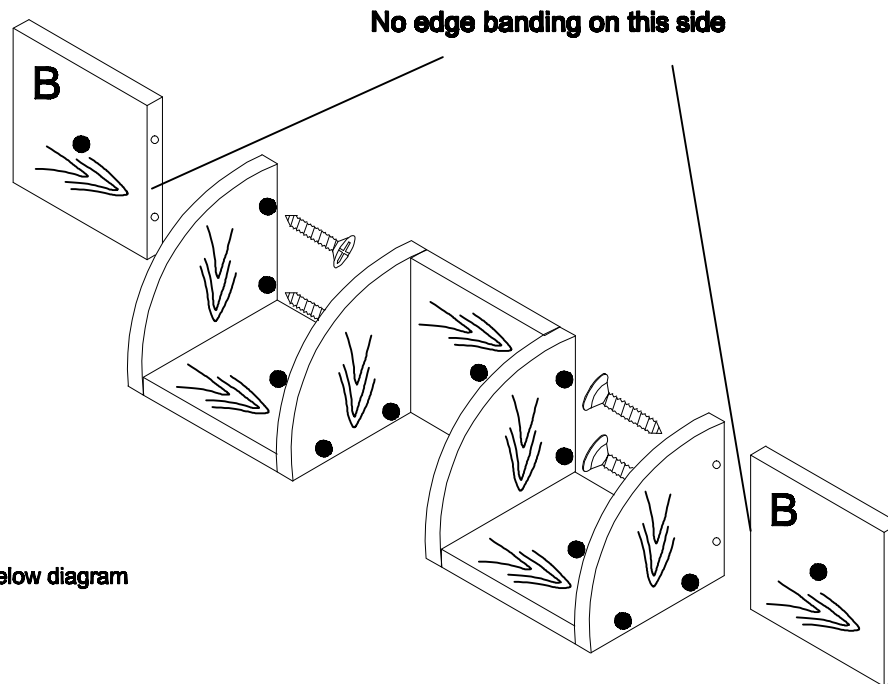

- Indicating countersunk hole
- Indicating regular screw hole

 Please follow woodgrain direction as below diagram when assembly

4.

